



# Harry Potter



4842



1

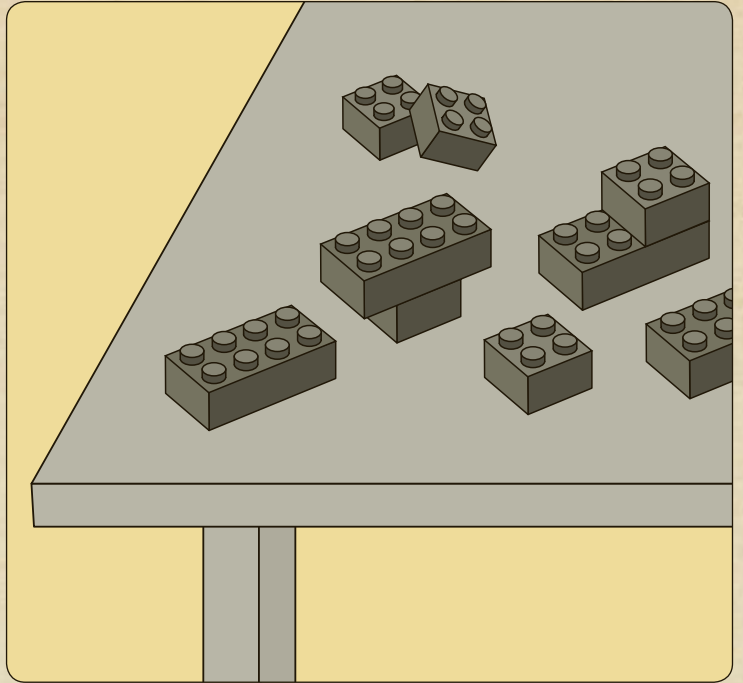
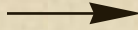
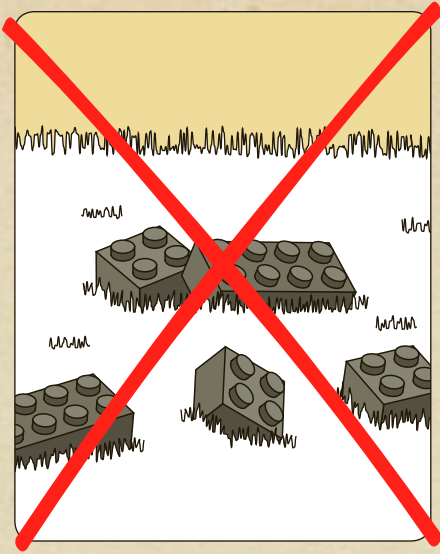

2

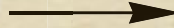

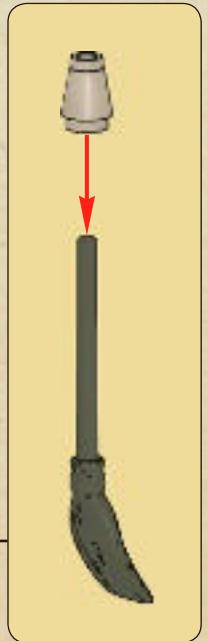
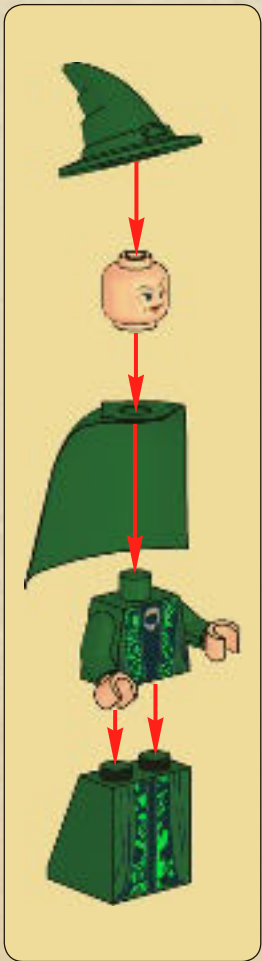

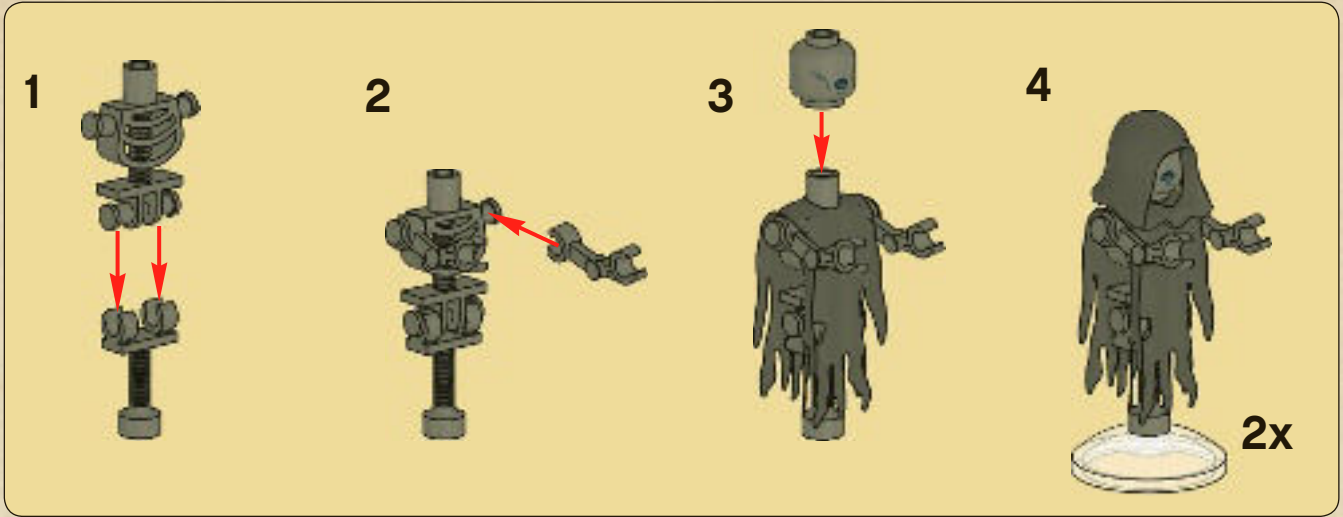

**1**

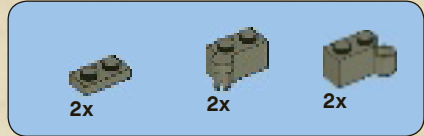
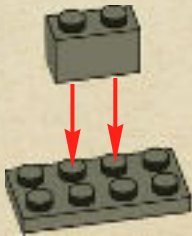

**2**

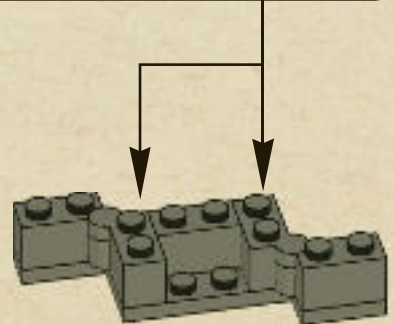
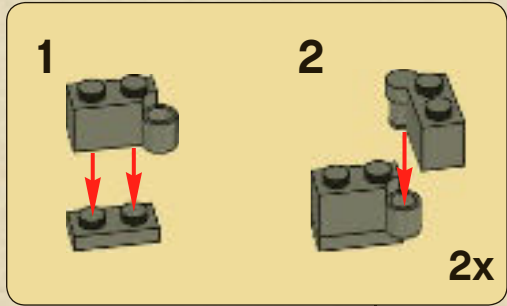



3

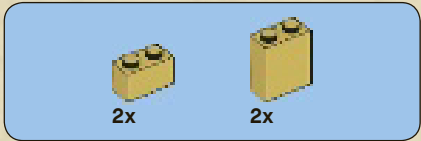
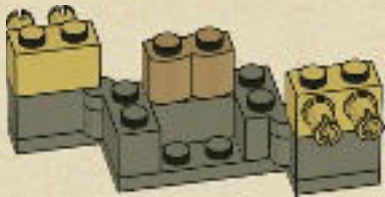

4

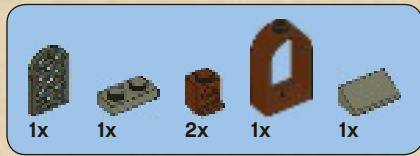
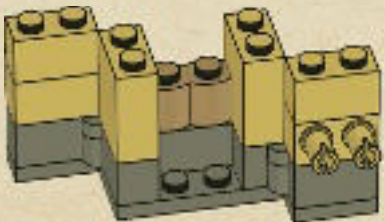

5

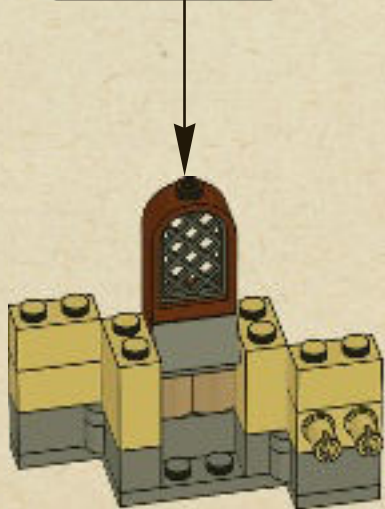



2x

6

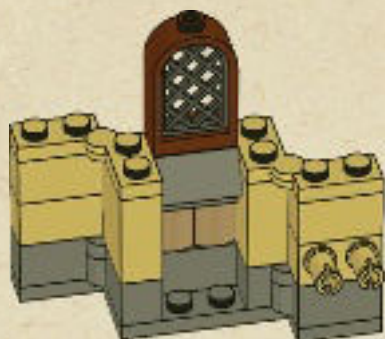

1x



2x

8

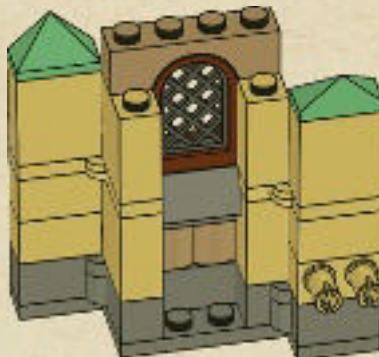

4x

7

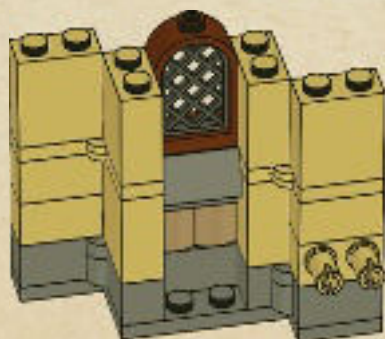

2x

9

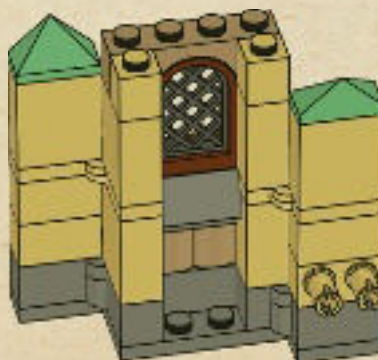



2x

# 10

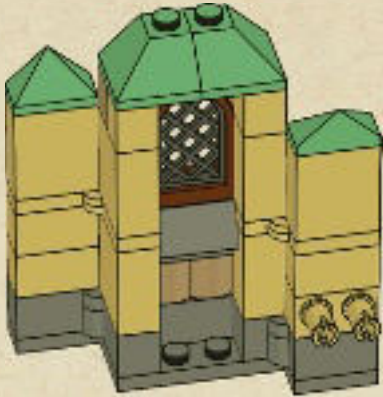

1x



1x

# 11

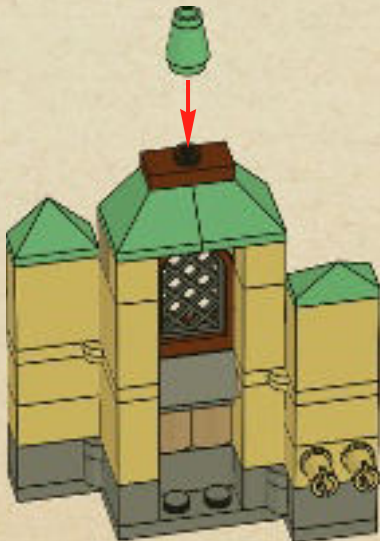

2x



1x



1x

# 1

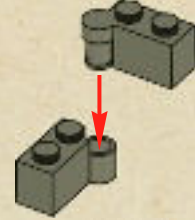

2x

# 2

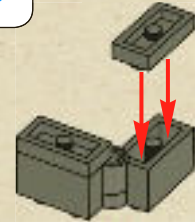
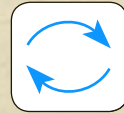

2x

# 3

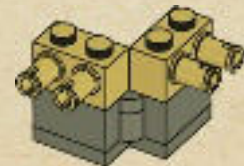



1x

4

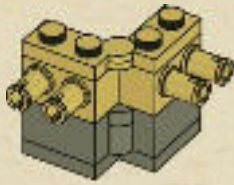

2x

6

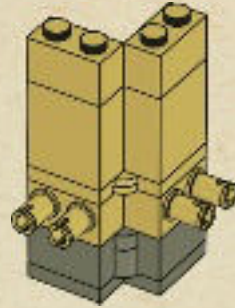

2x

5

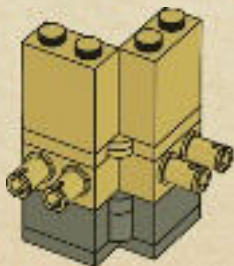

2x

7

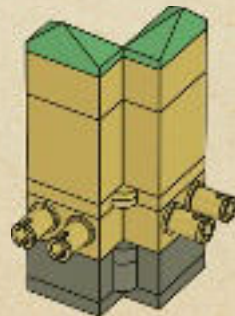

2x



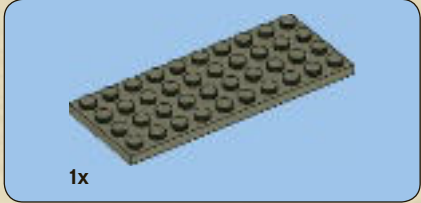
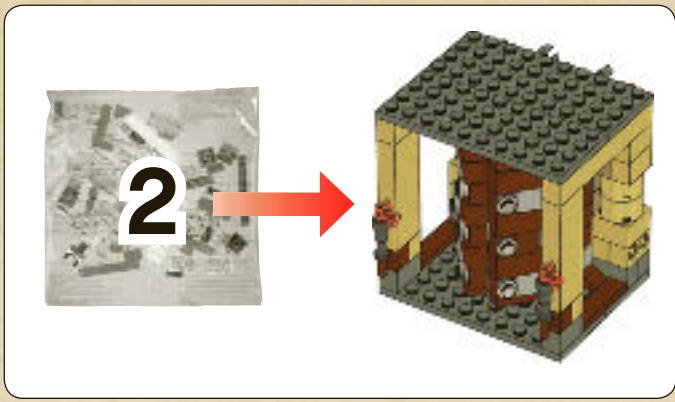

1

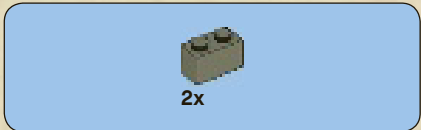
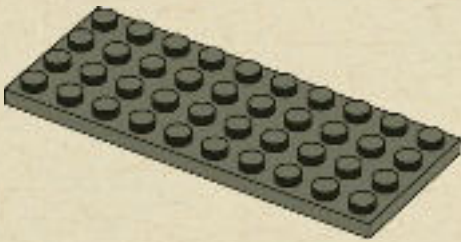

2

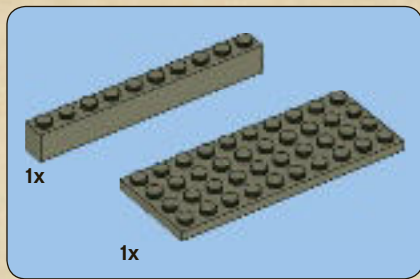
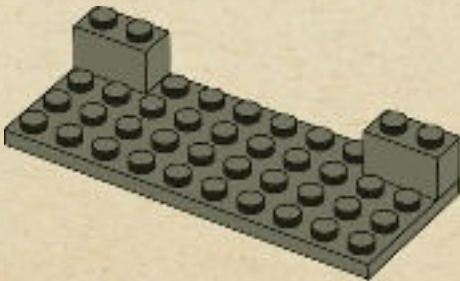

3

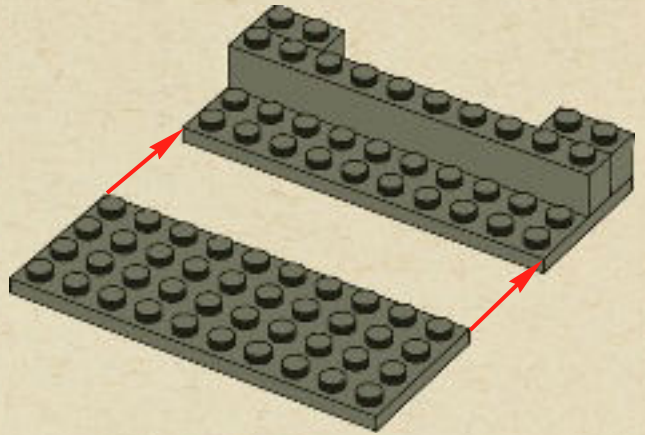

4

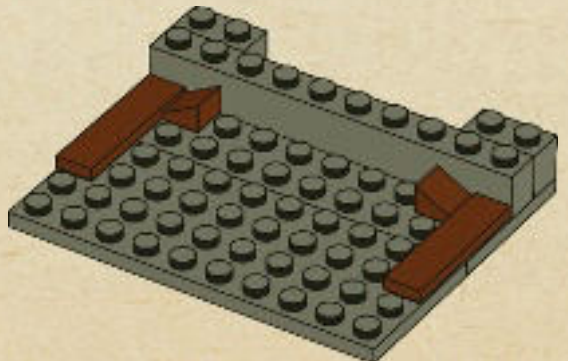



5

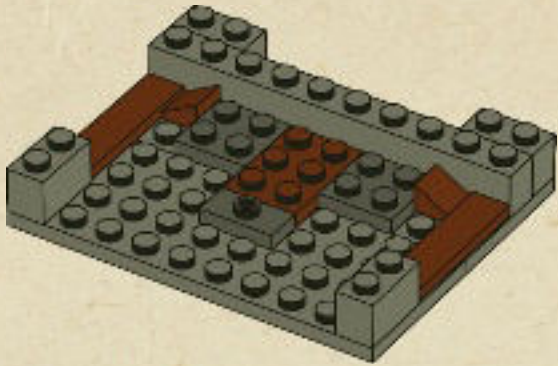

7

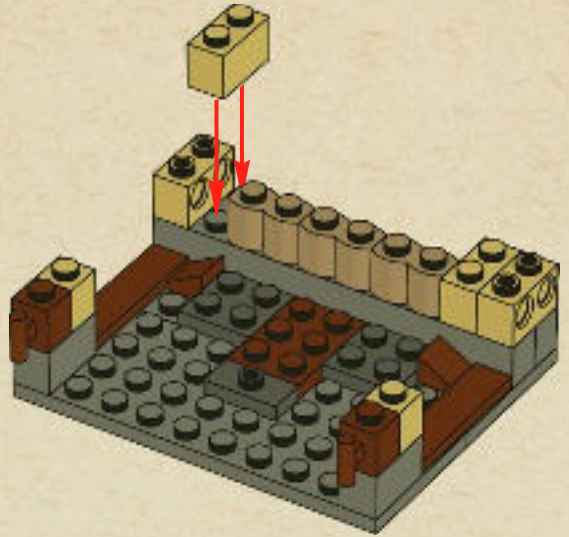

6

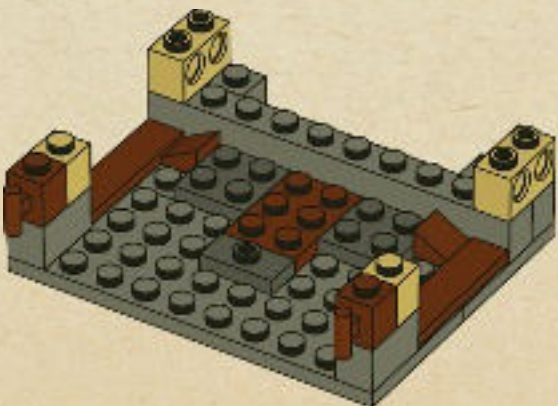

8

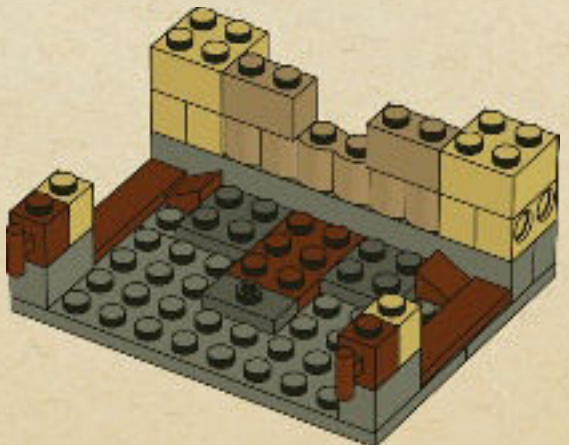



9

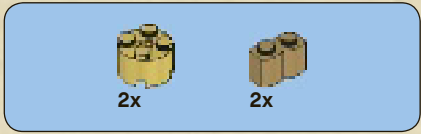
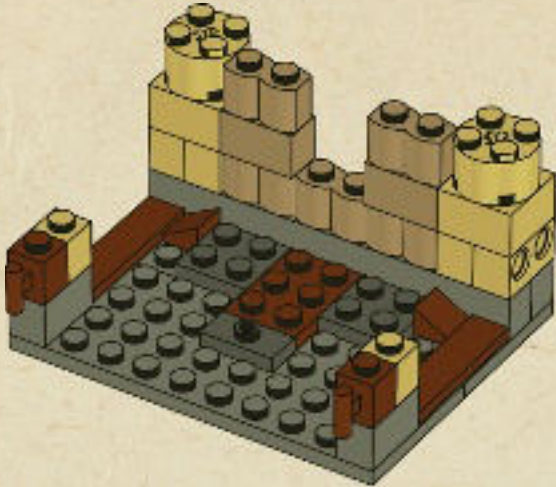

10

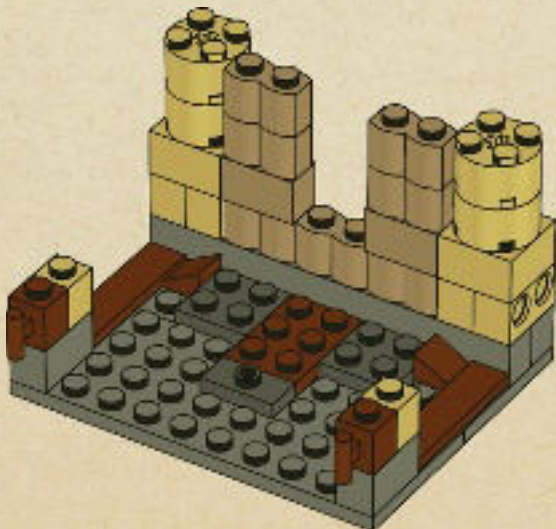

11

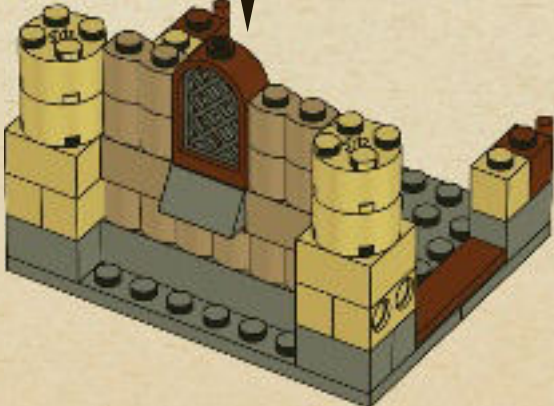

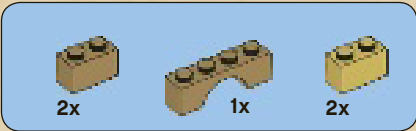

# 12

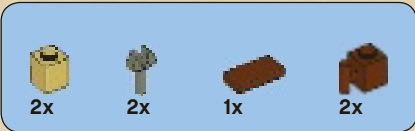
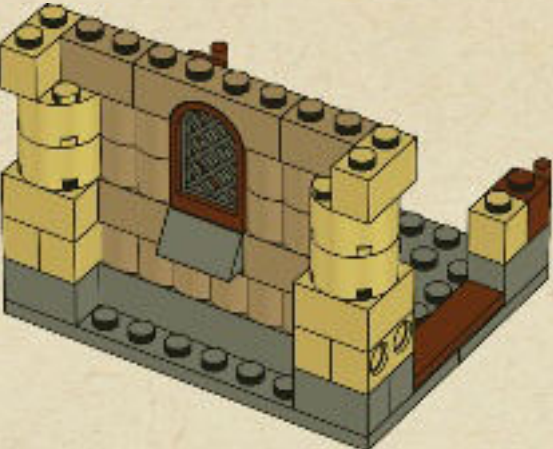

# 14

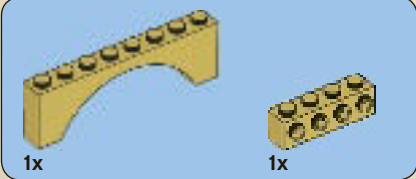
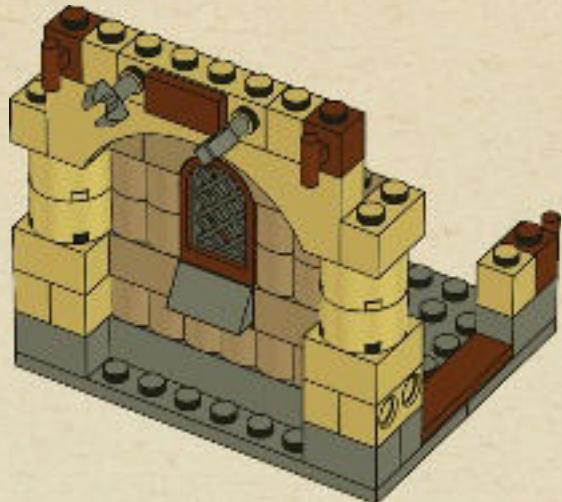

# 13

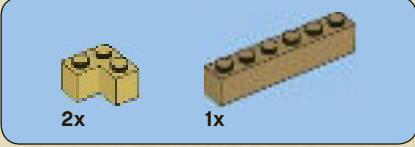
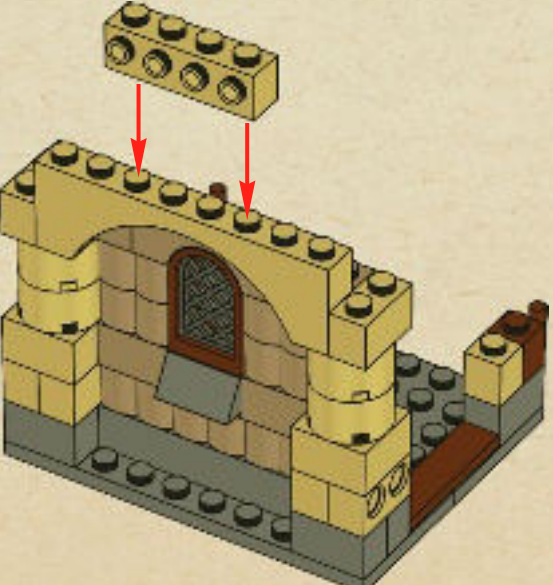

# 15

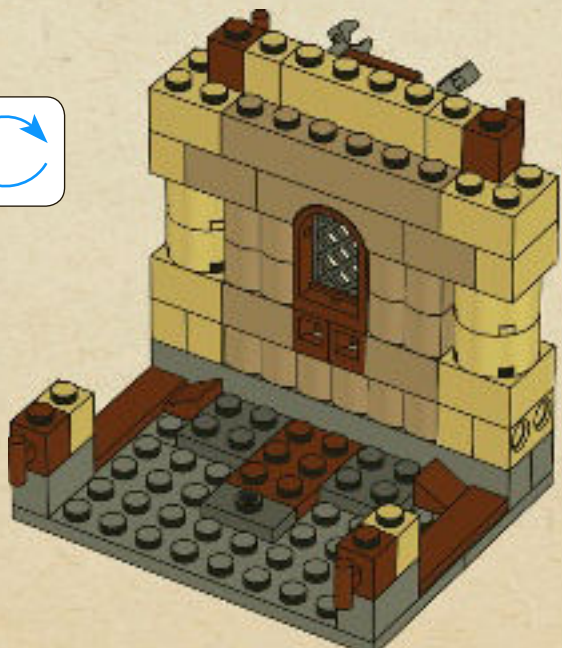

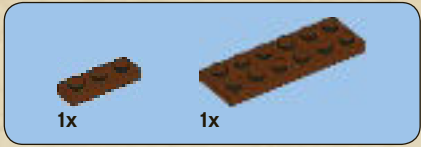

1

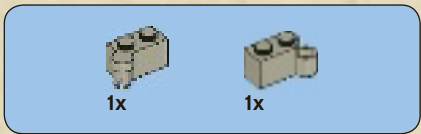
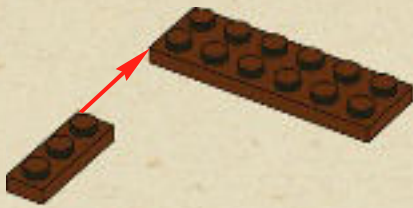

2

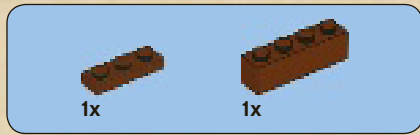
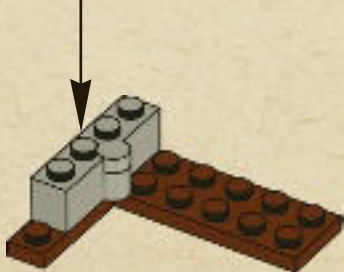
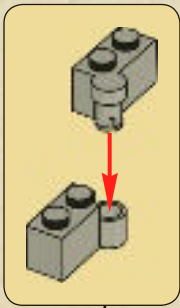

3

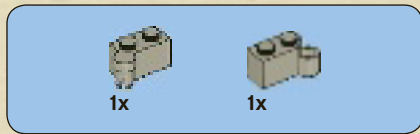
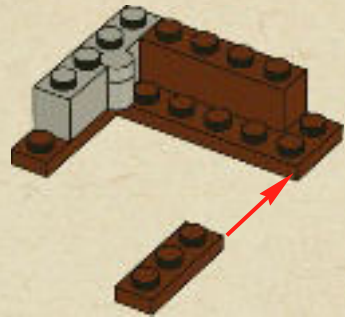

4

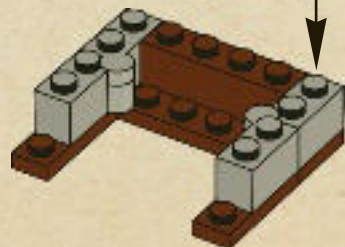
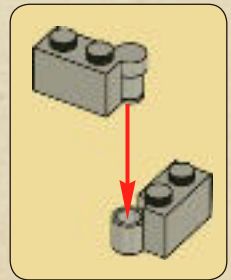



5

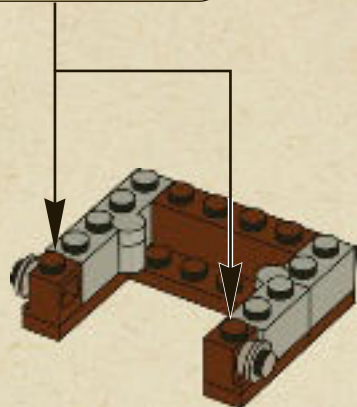

6

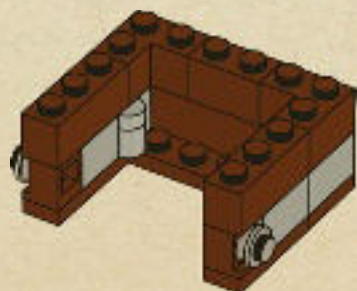

7

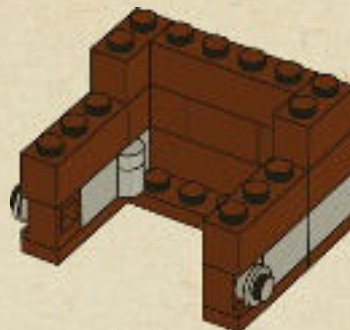

8

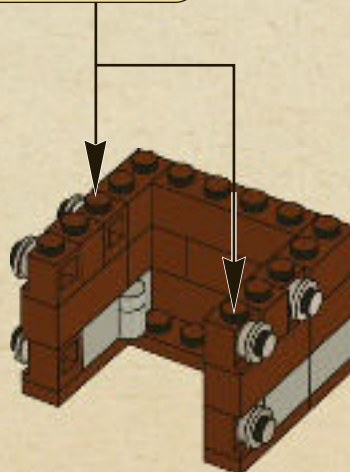



9

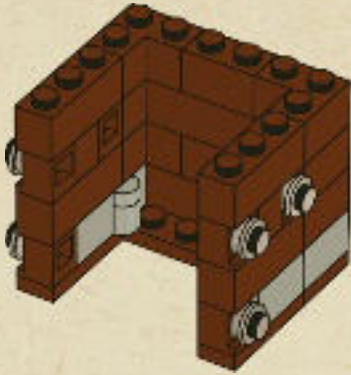

11

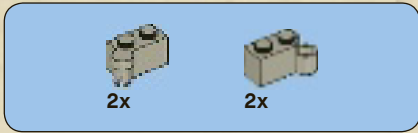
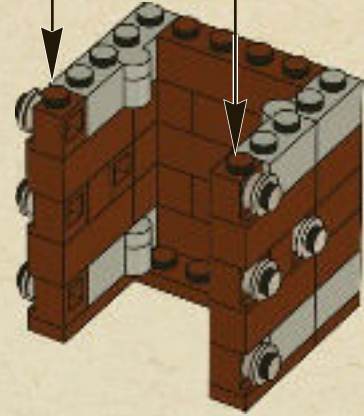

10

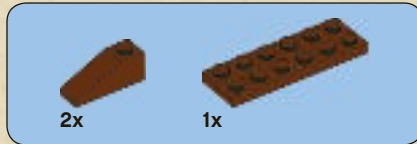
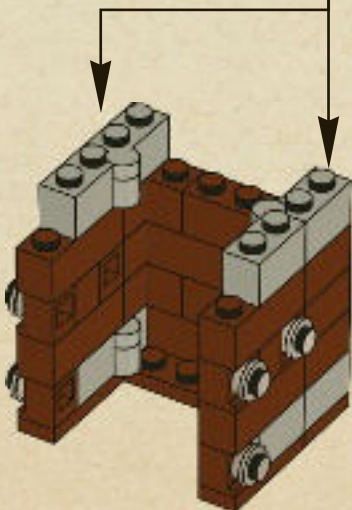
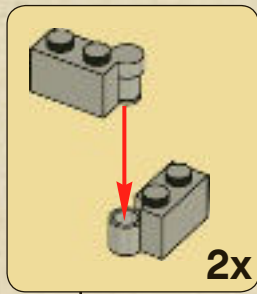

12

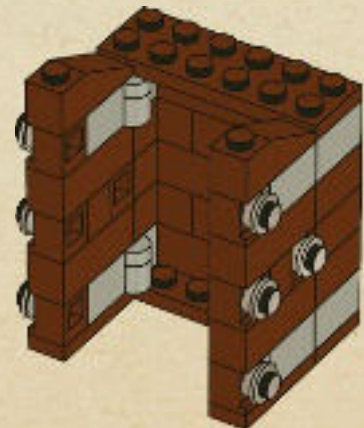

2x

13

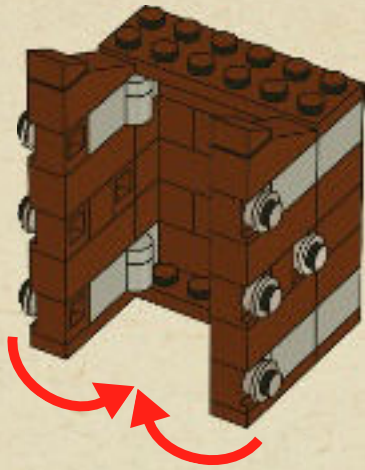

2x

17

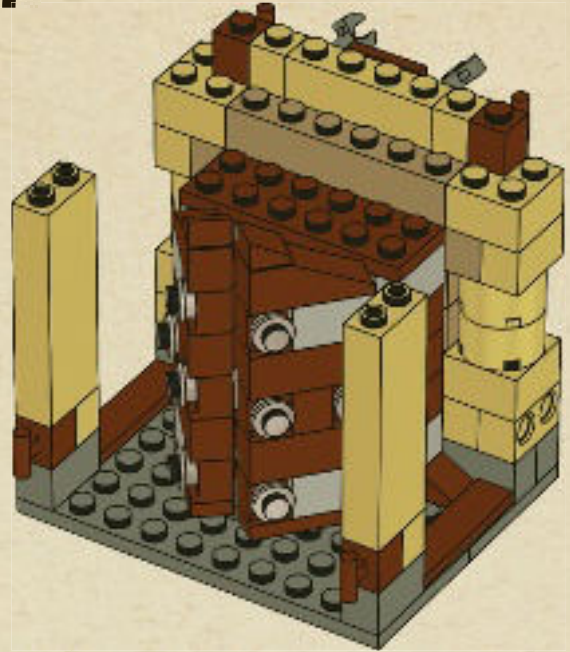

2x

16

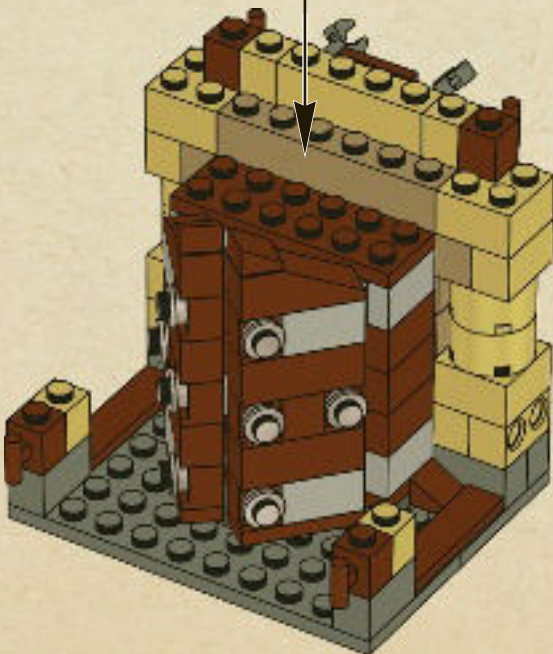

18

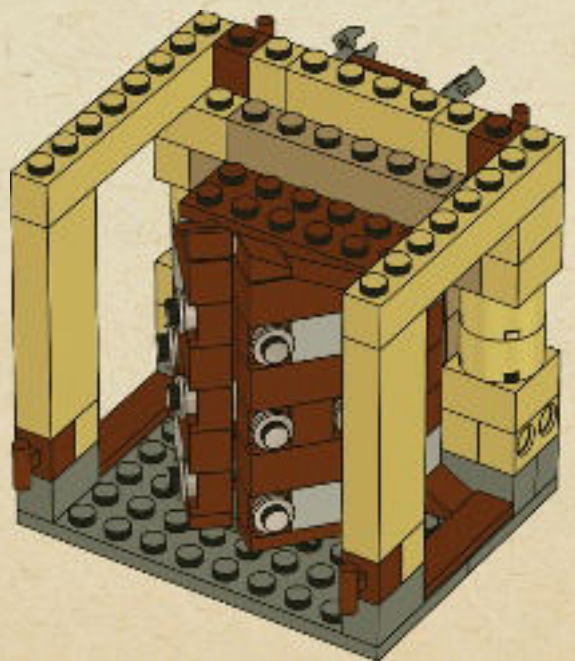



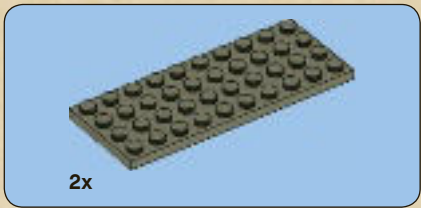

19

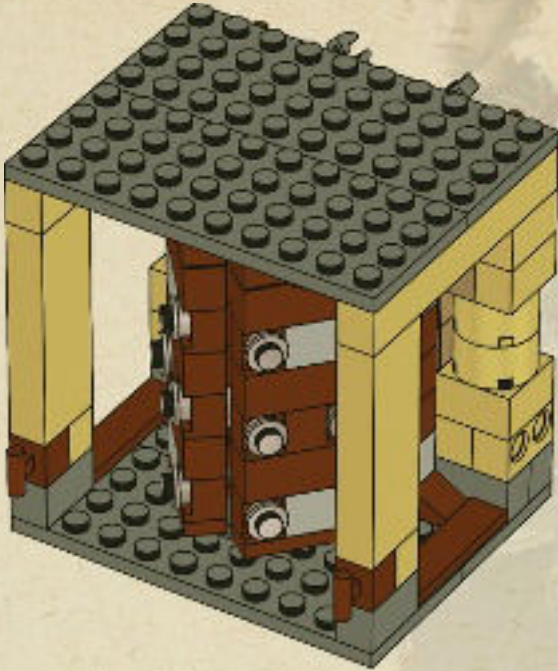

20

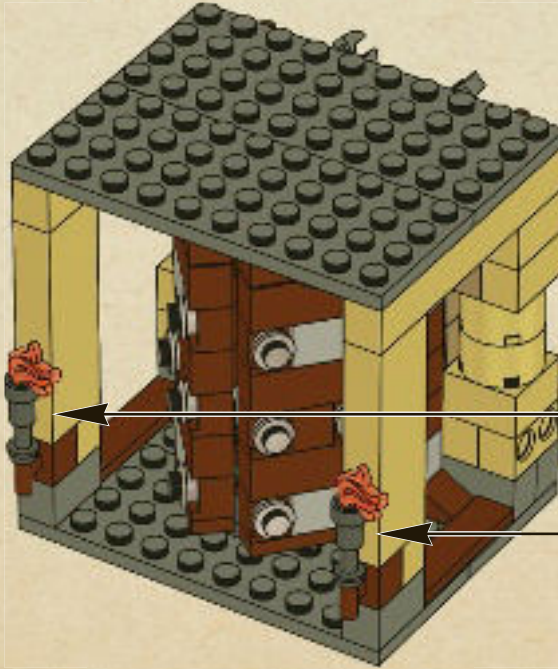
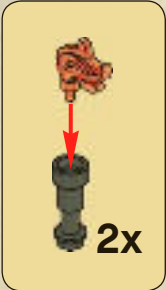



3

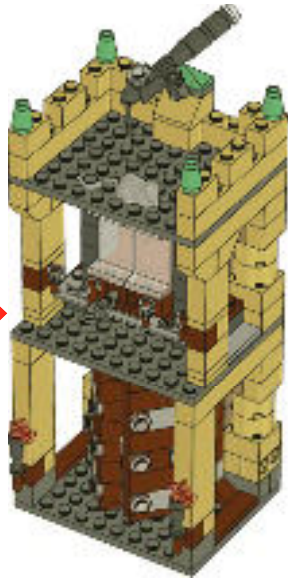

2x



3x

21

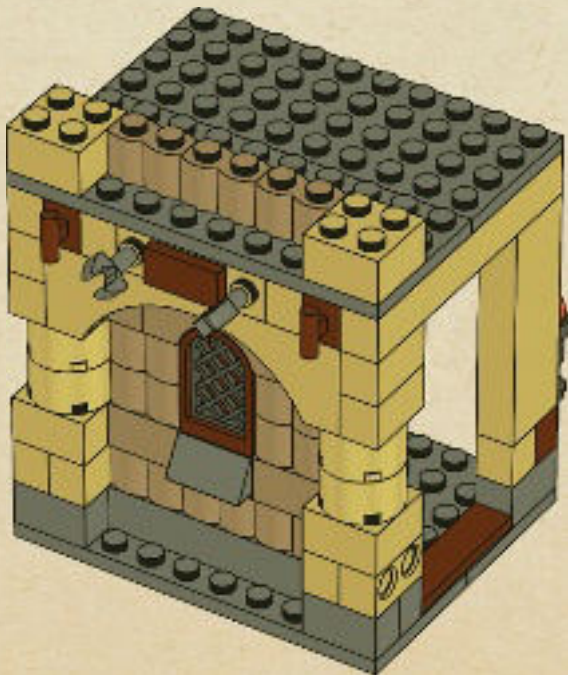

2x



2x

22

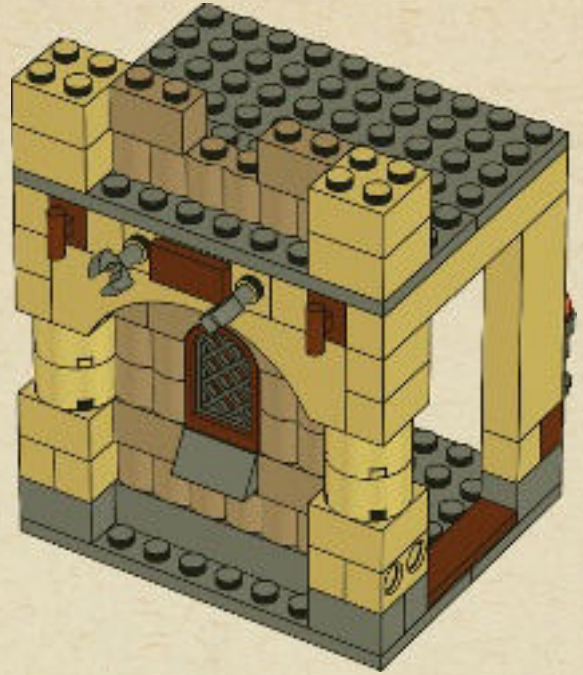

2x



2x

23

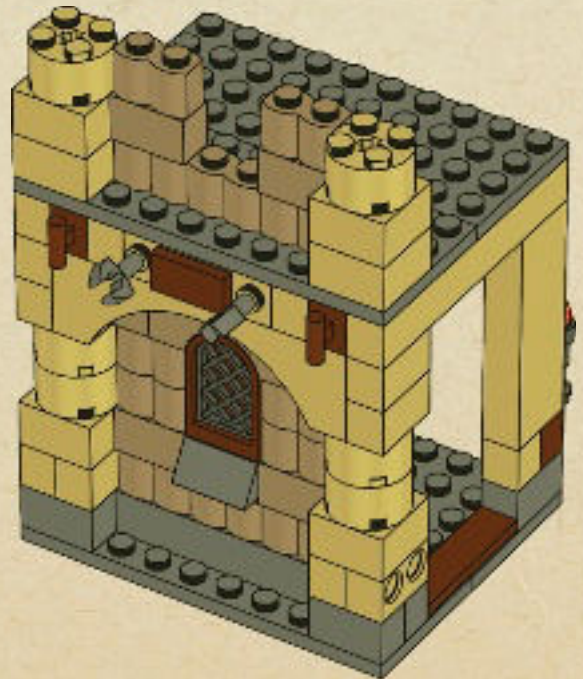

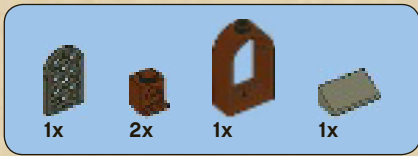

# 24

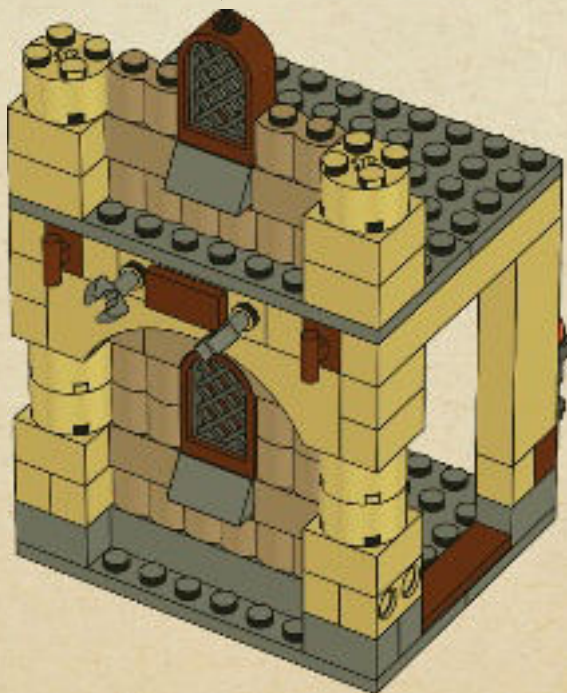

# 25

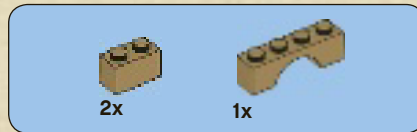
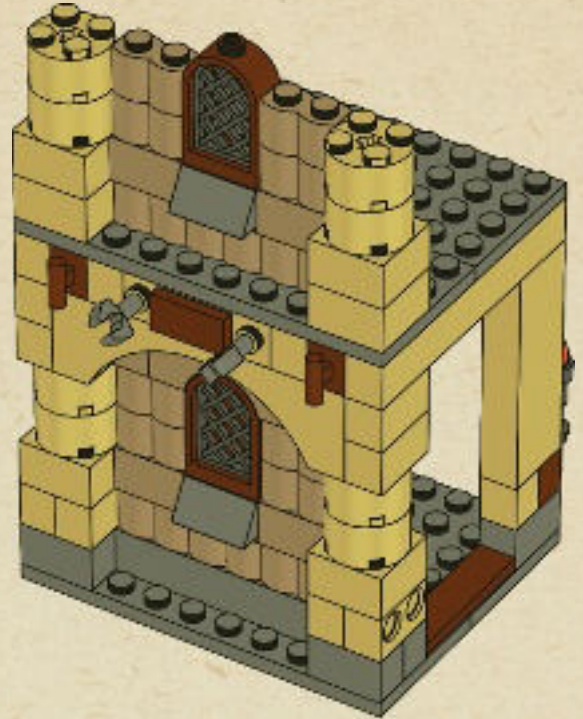

# 26

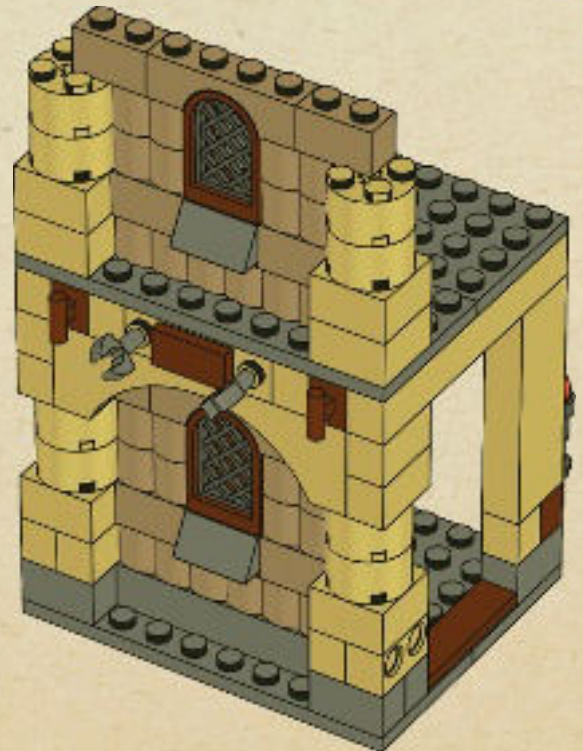

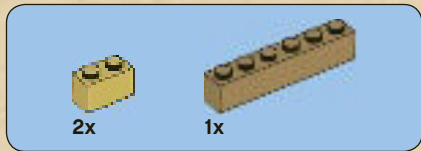

27

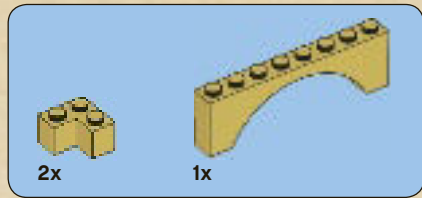
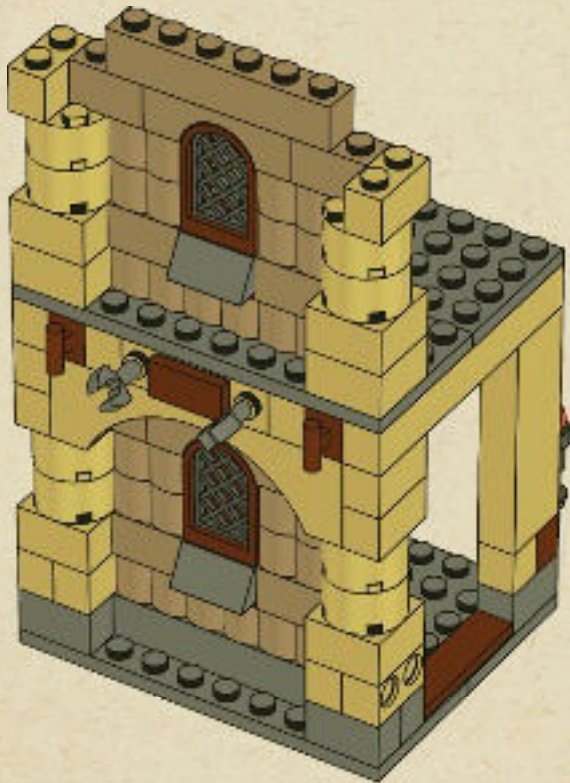

28

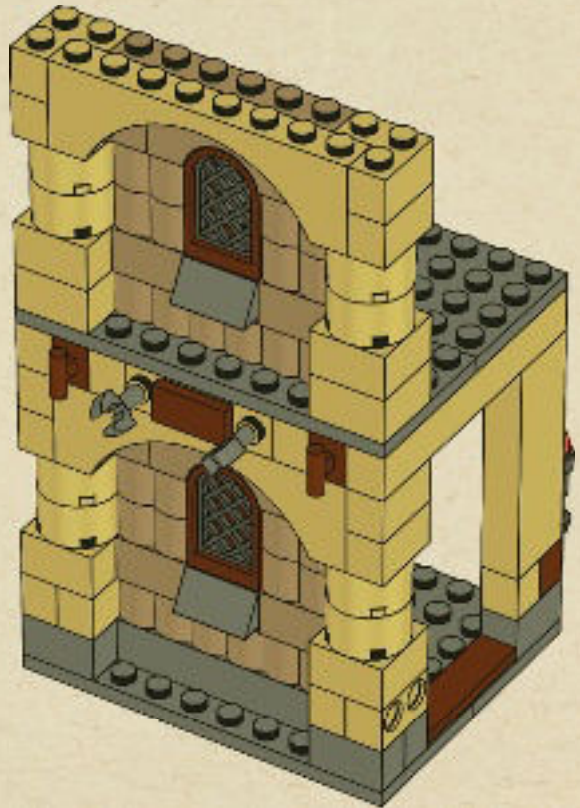



# 29

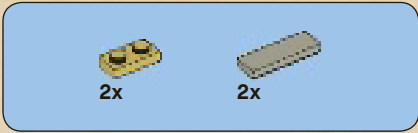
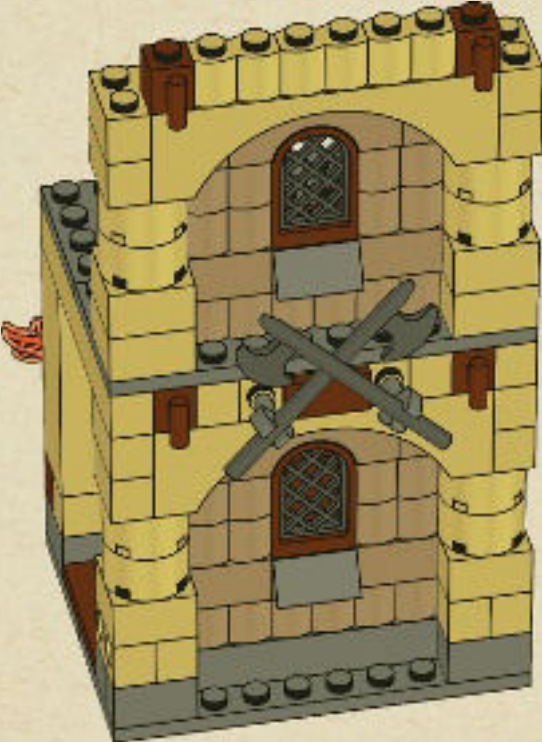

# 30

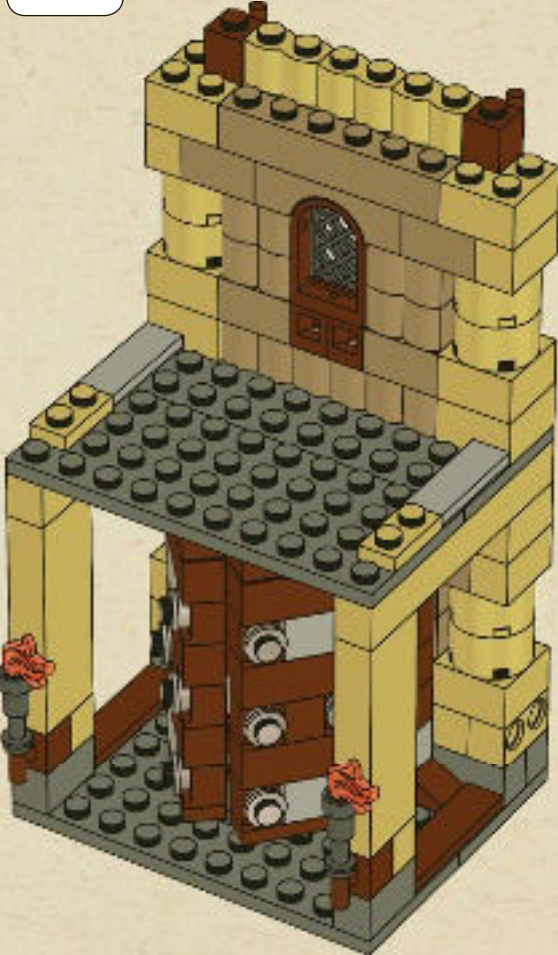



# 31

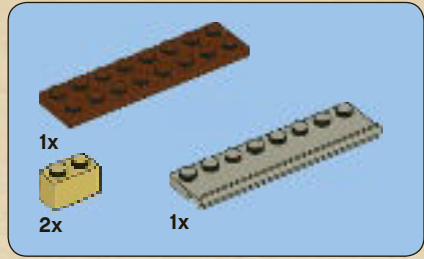

# 32

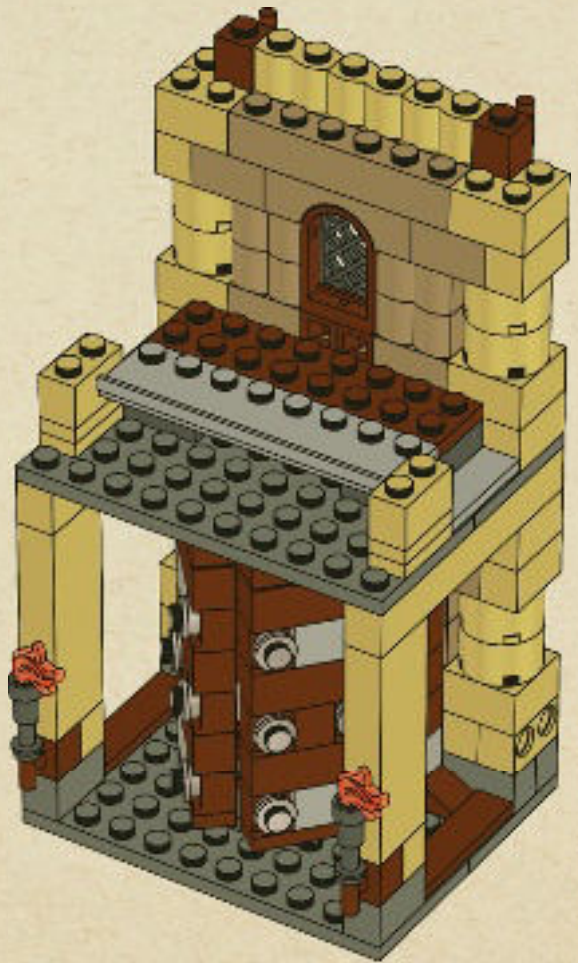



# 33

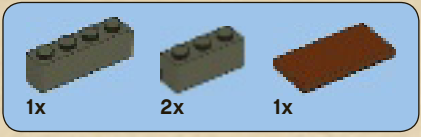
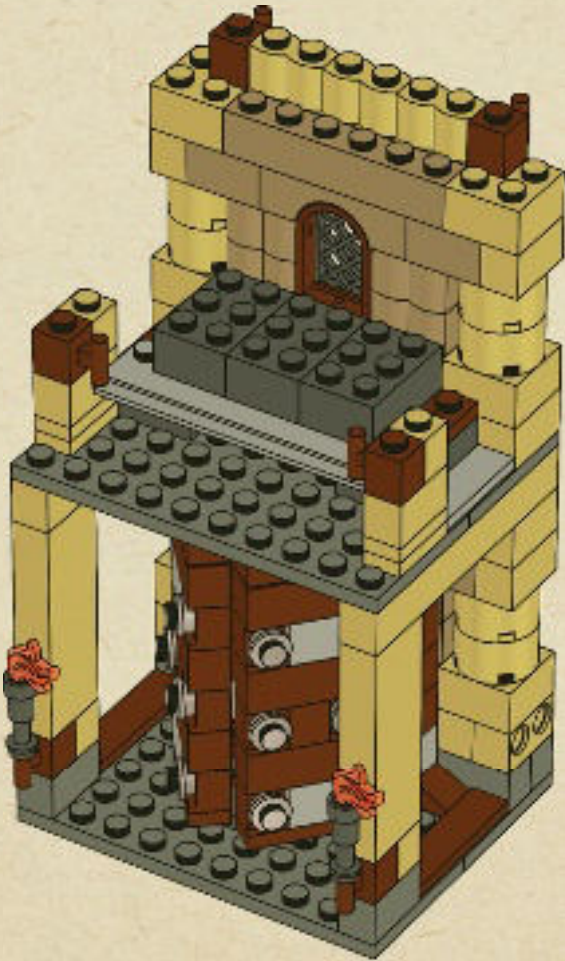

# 34

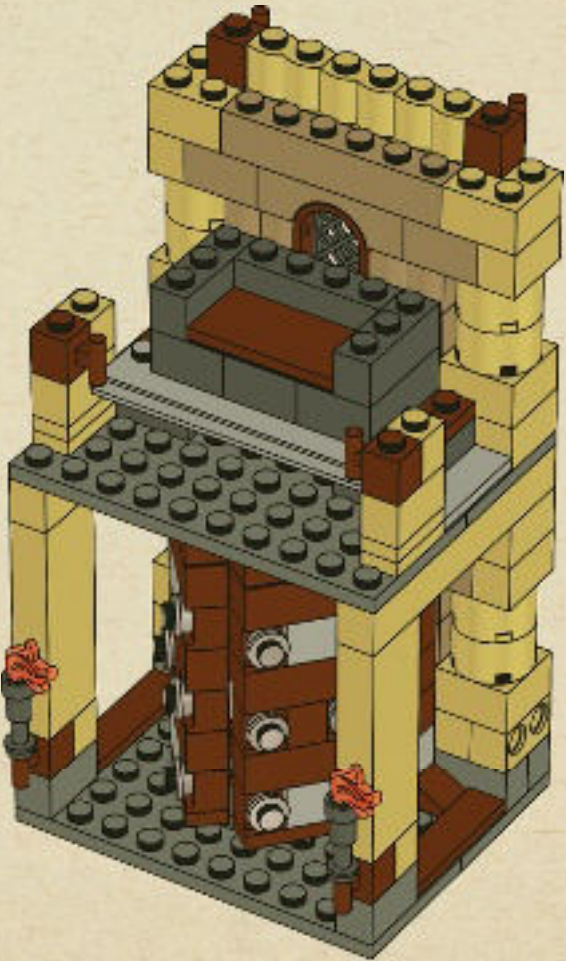

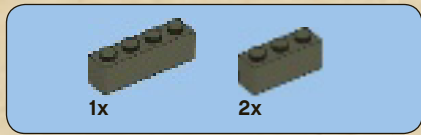

# 35

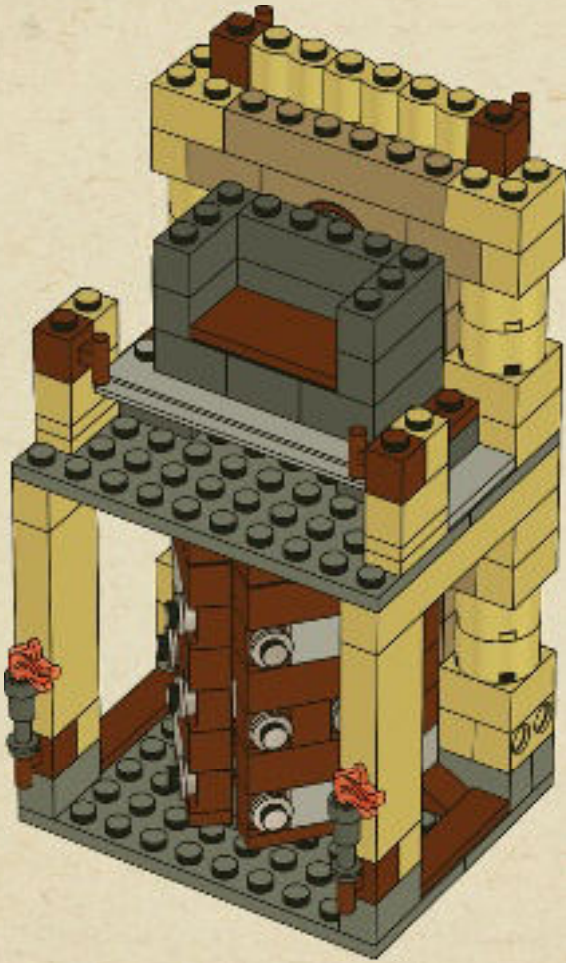

# 36

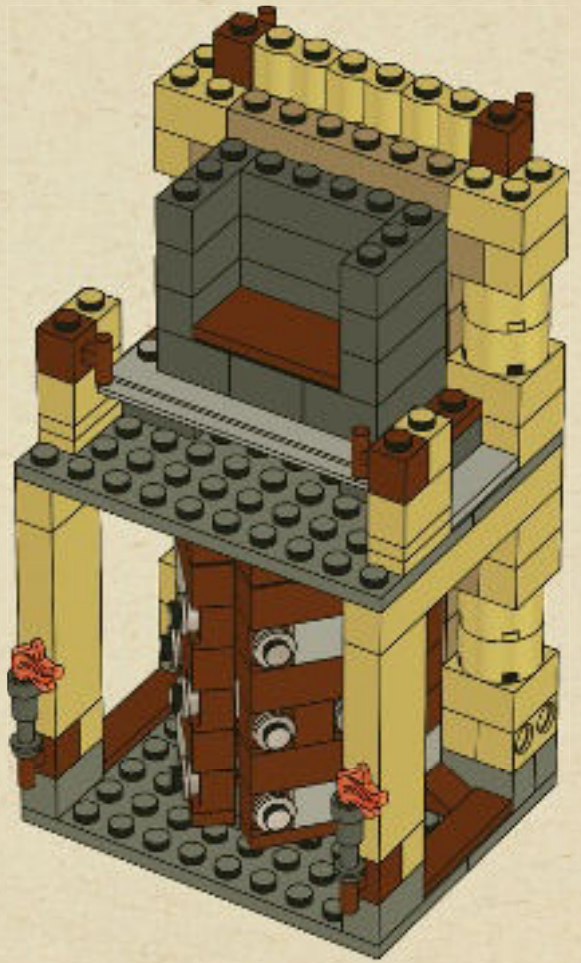





37

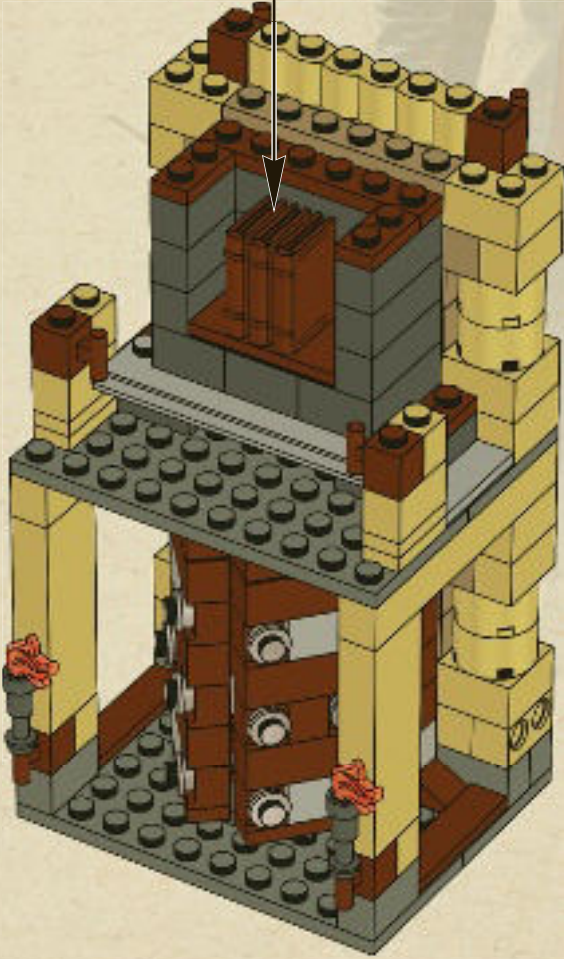

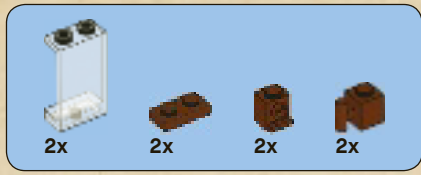

# 38

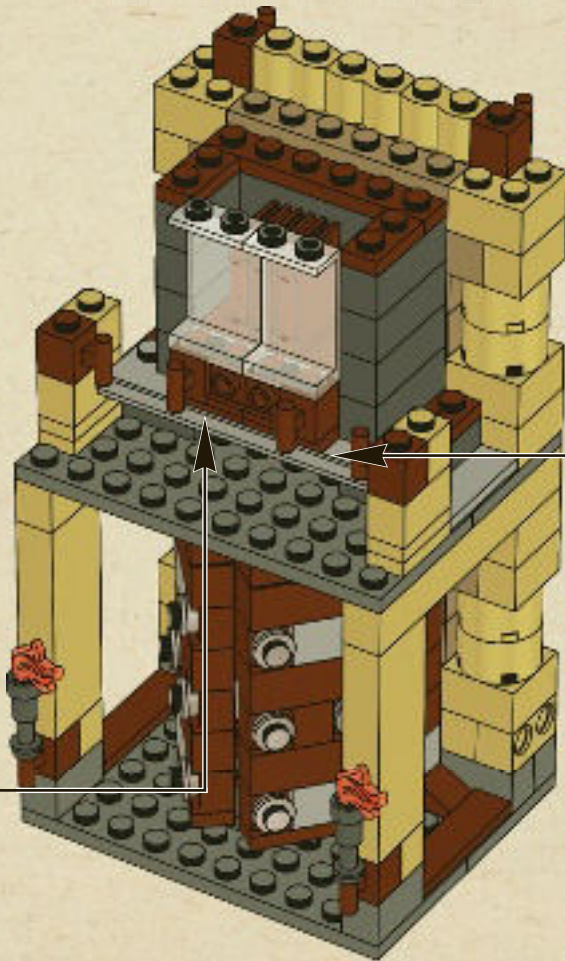

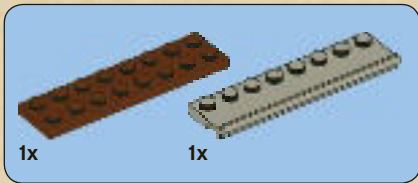

39

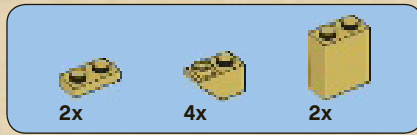
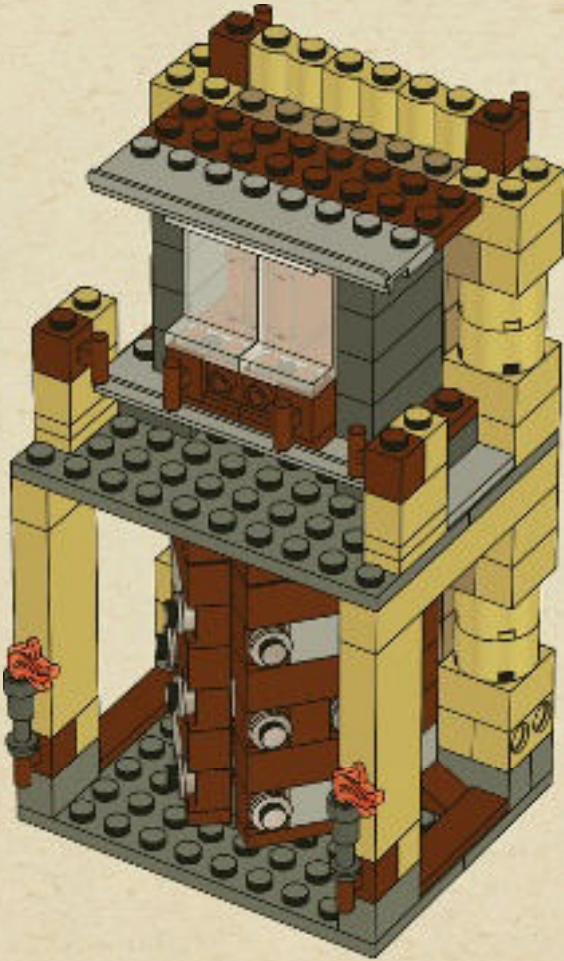

40

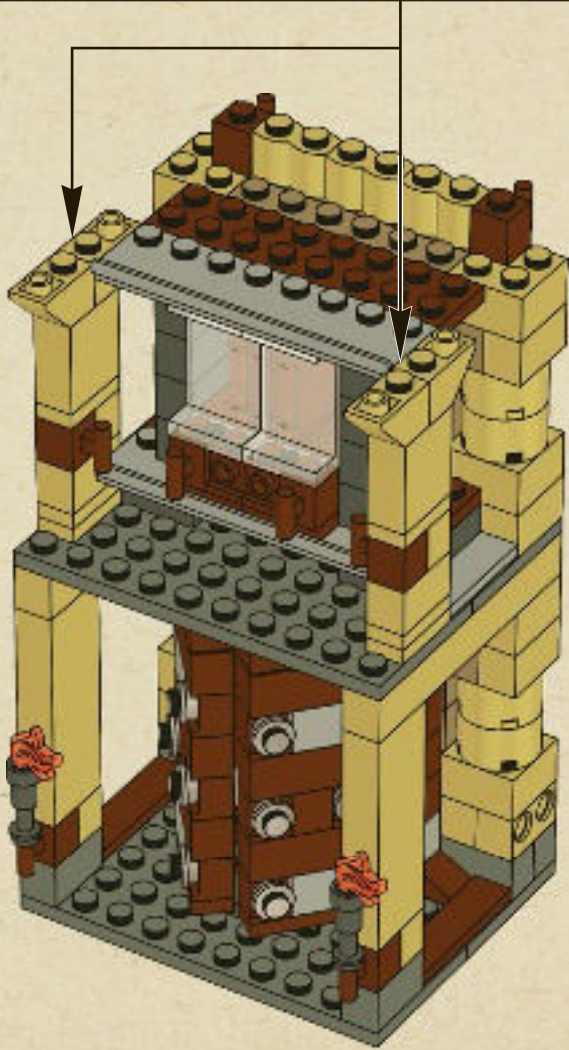
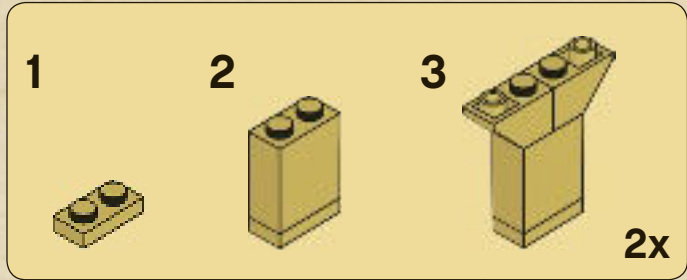

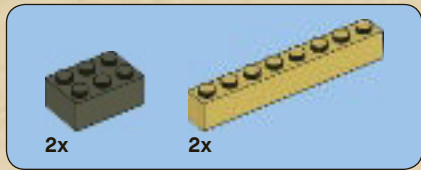

41

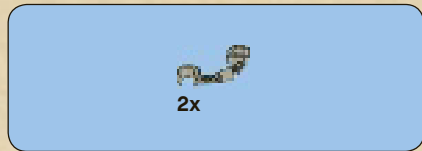
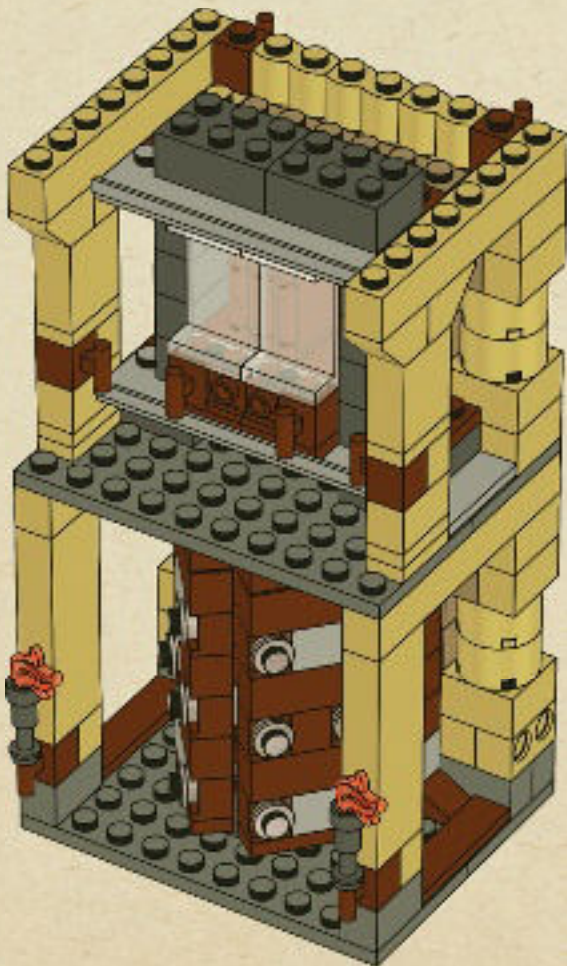
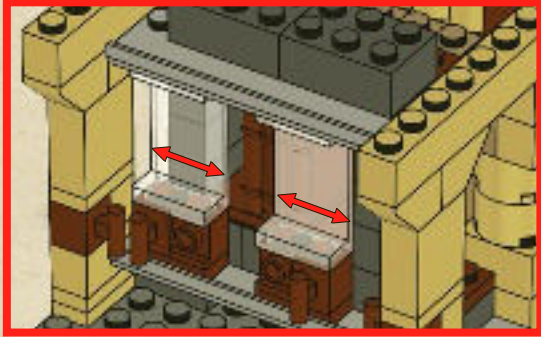

42

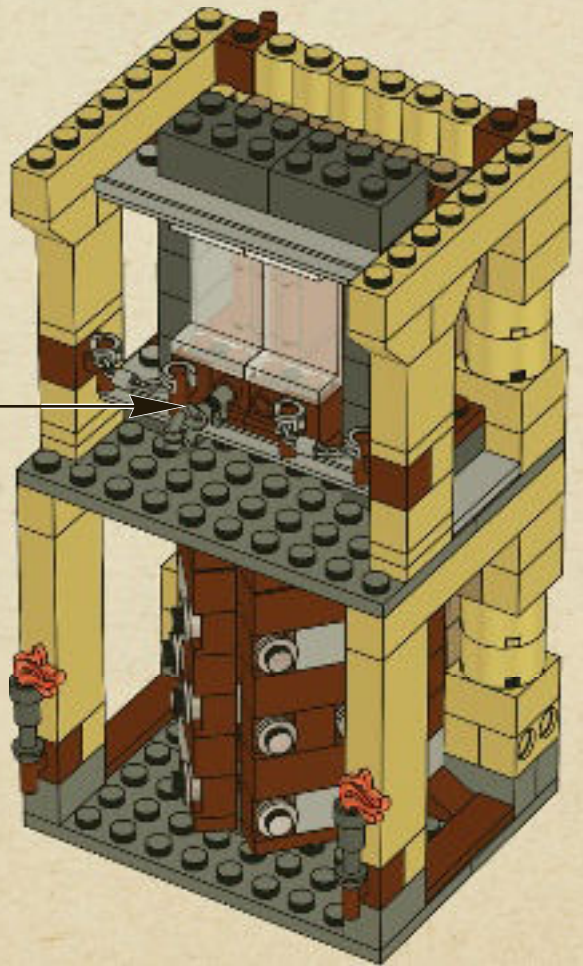

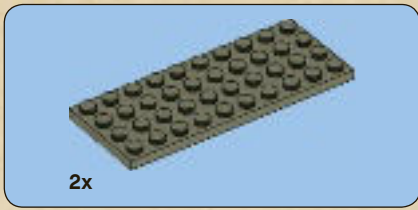

43

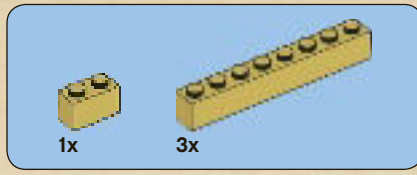
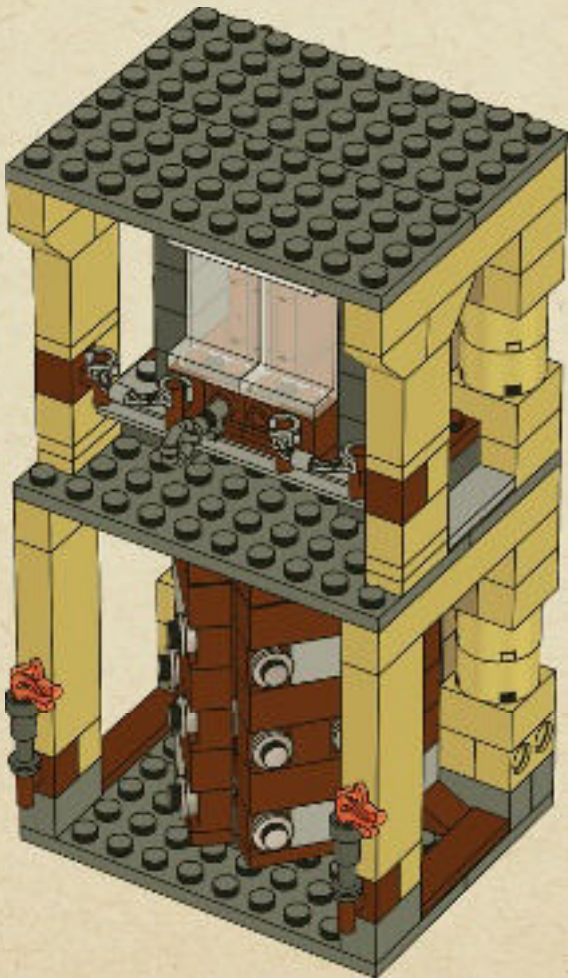

44

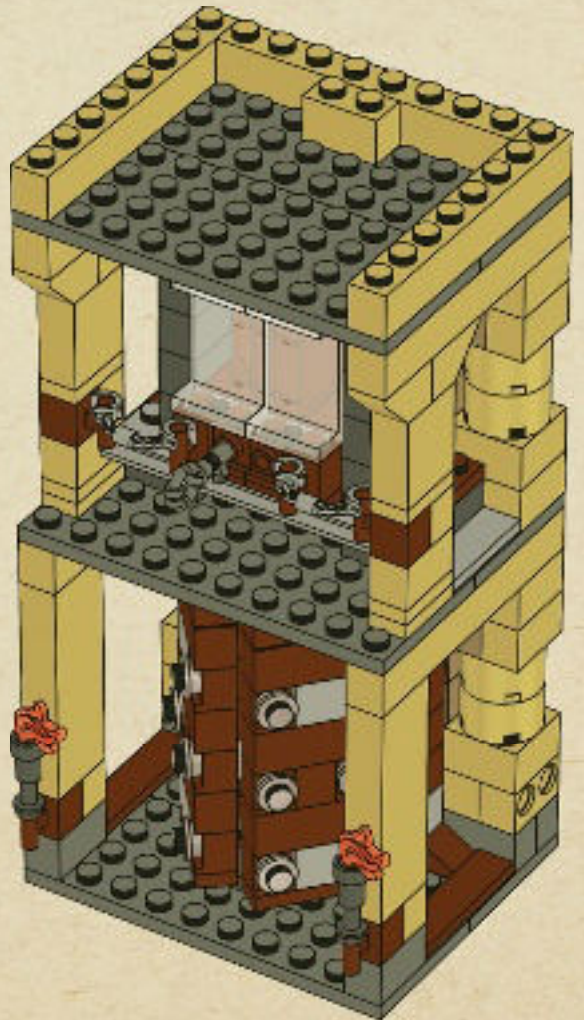



# 45

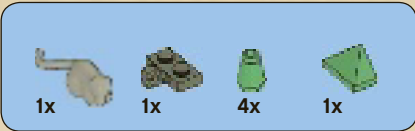
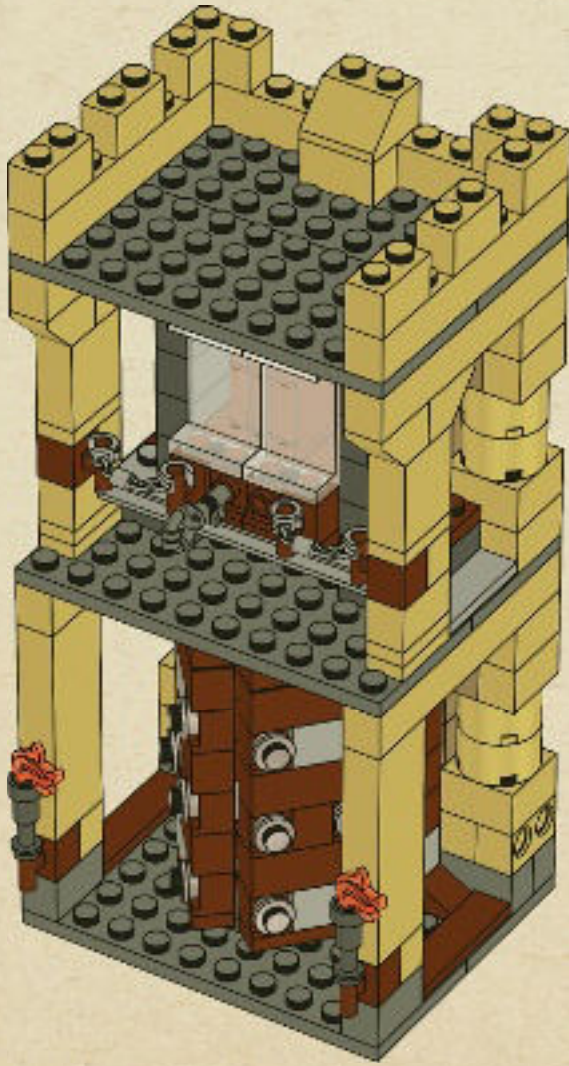

# 46





# 47

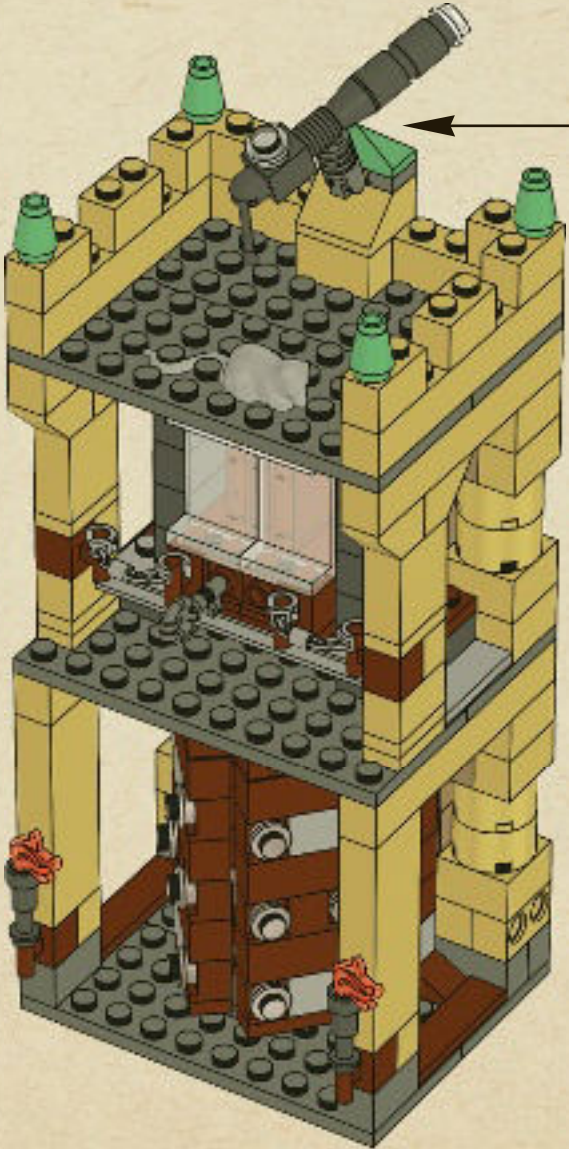
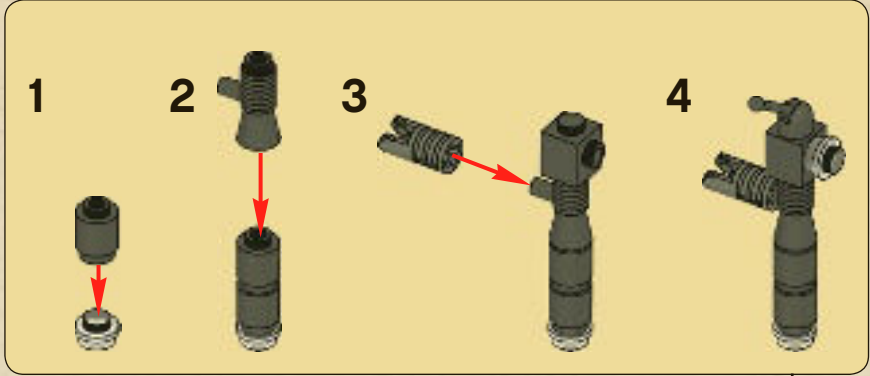

48

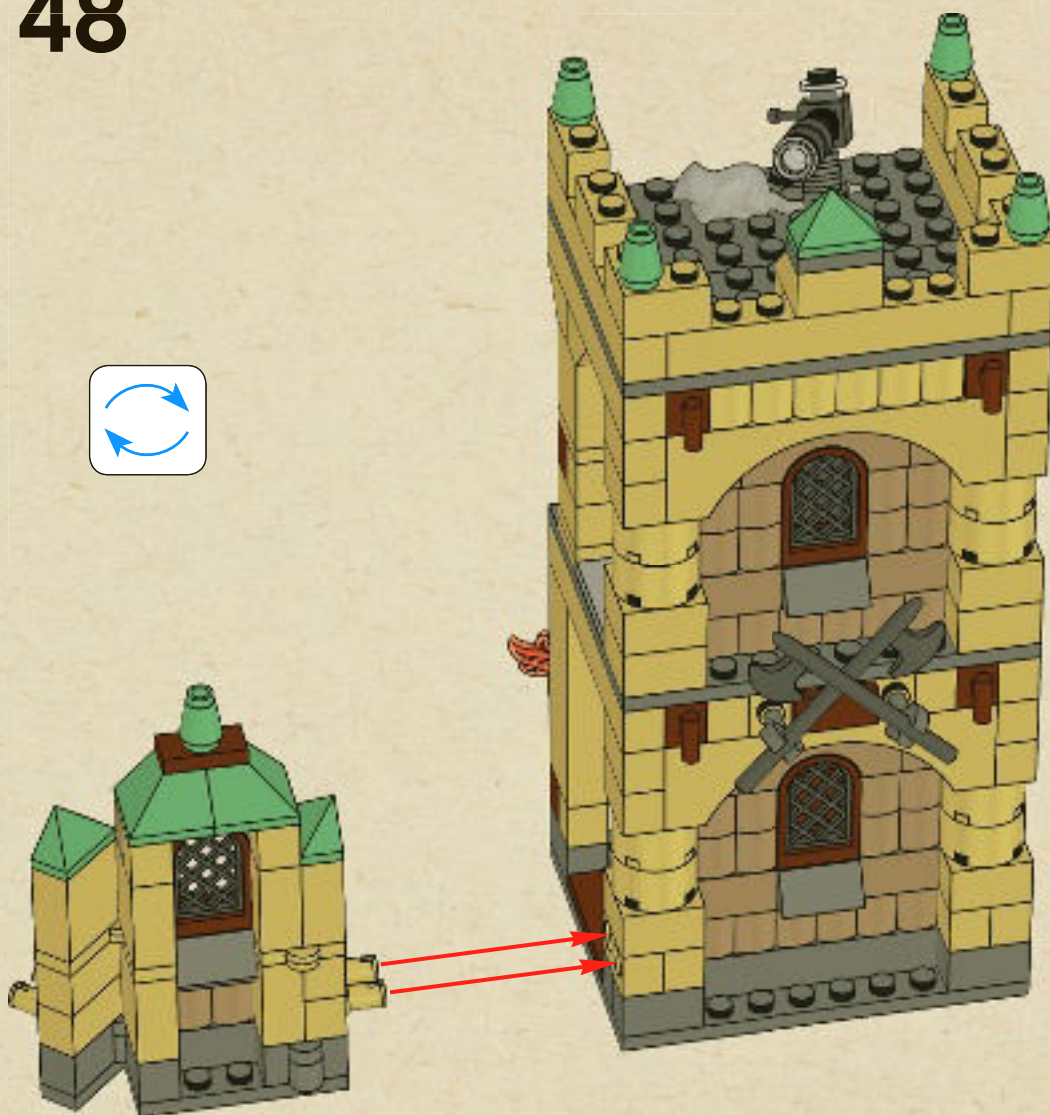



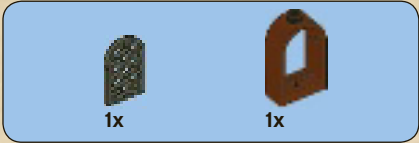
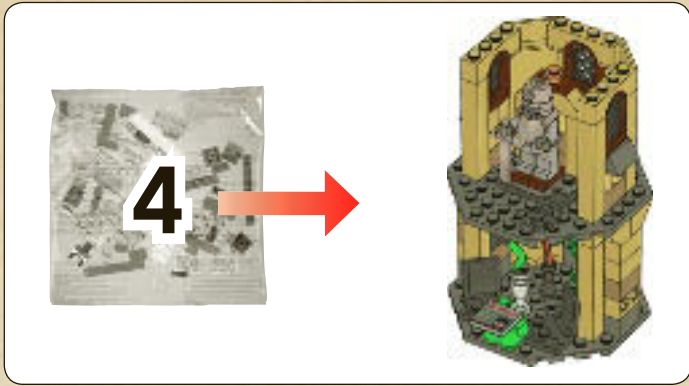

4



1

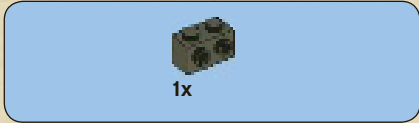
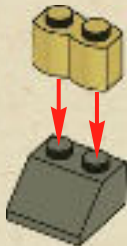

2

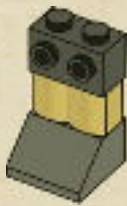

3

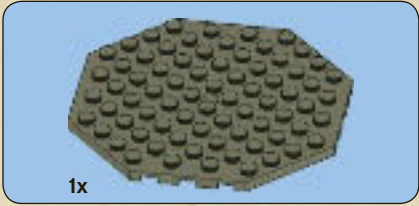
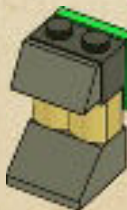
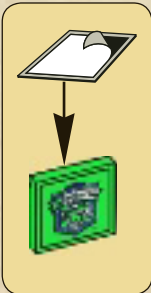

5

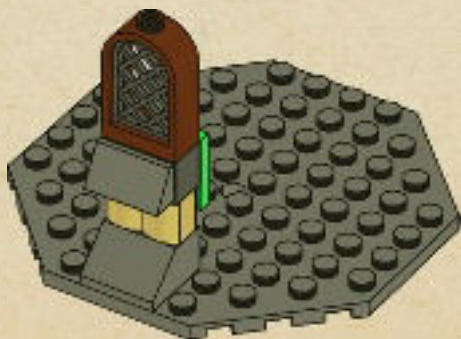

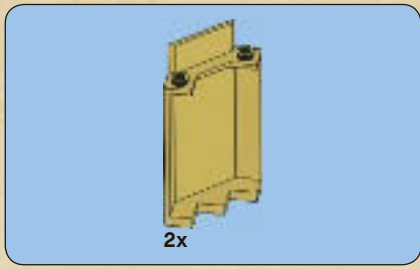

# 6

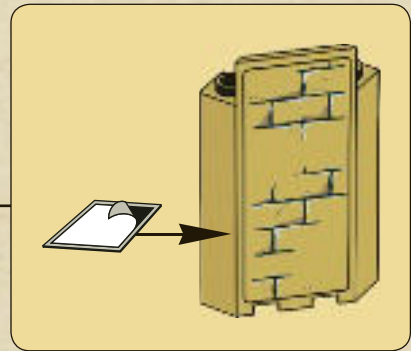
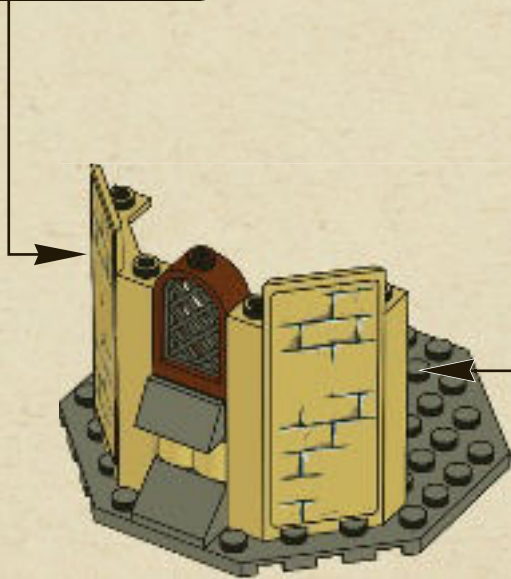
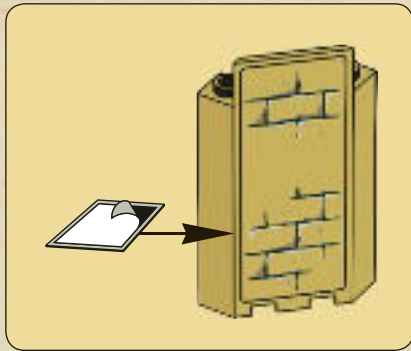

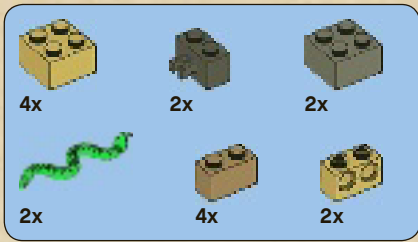

# 7

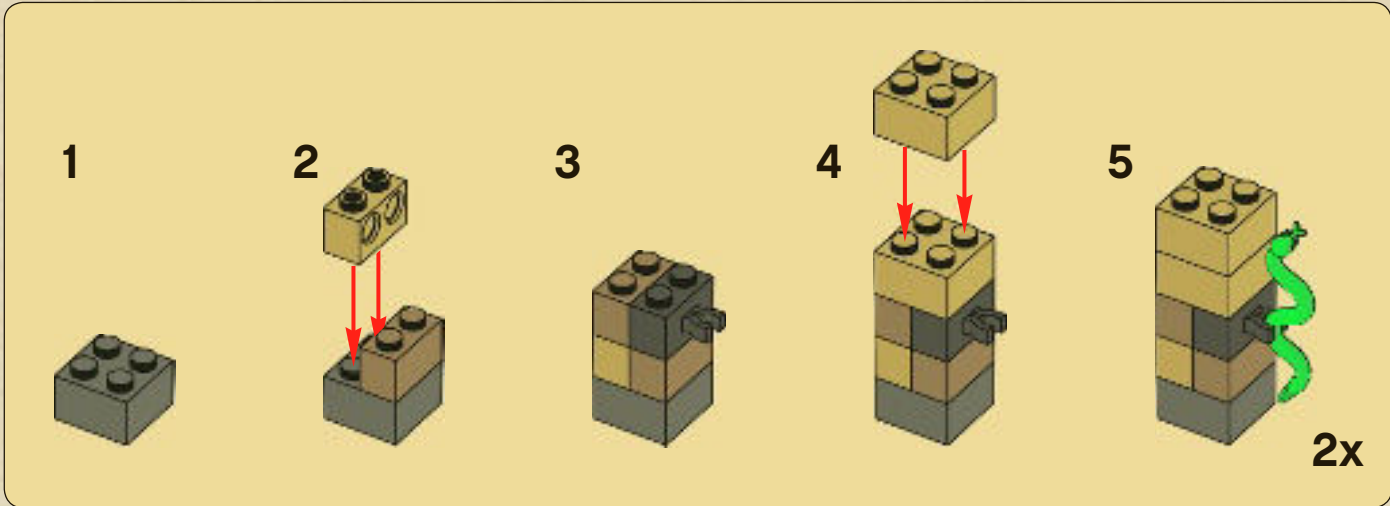



8

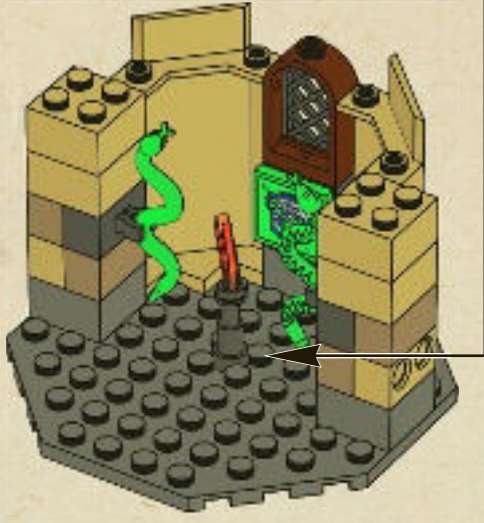

10

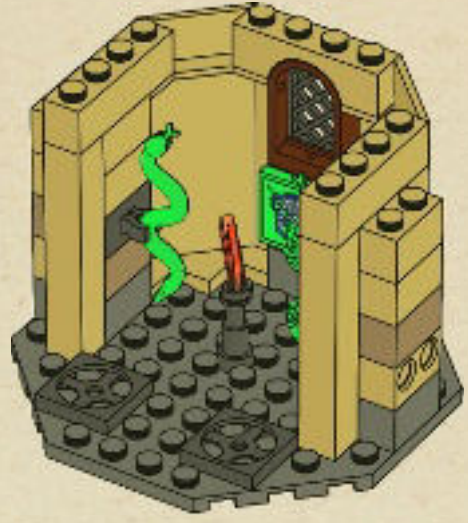

9

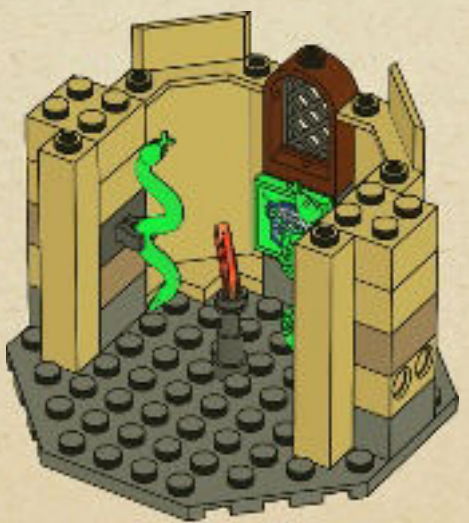

11

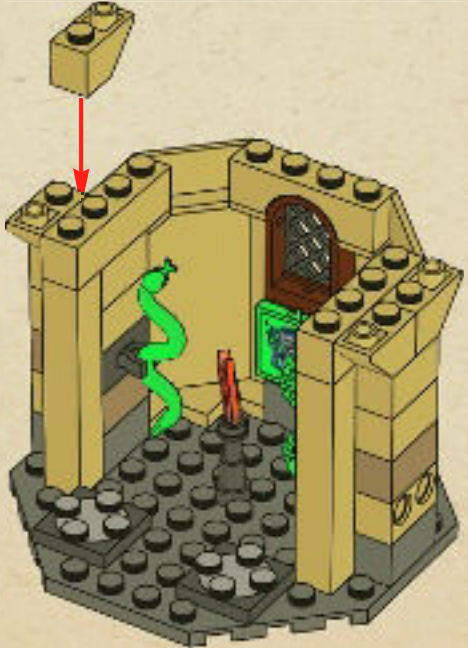

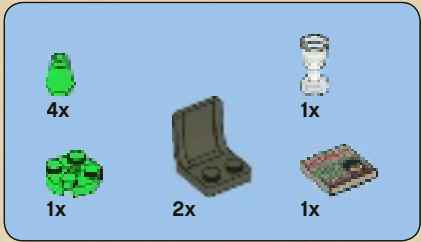

# 12

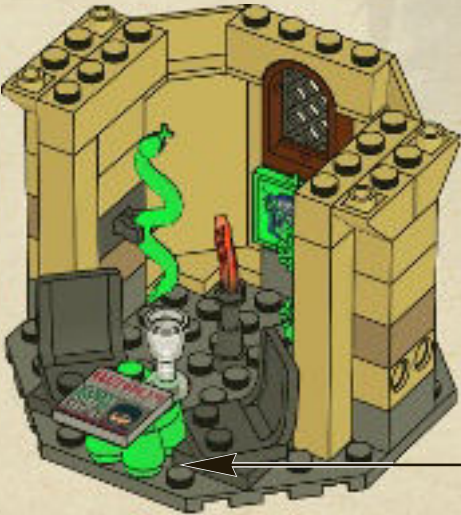
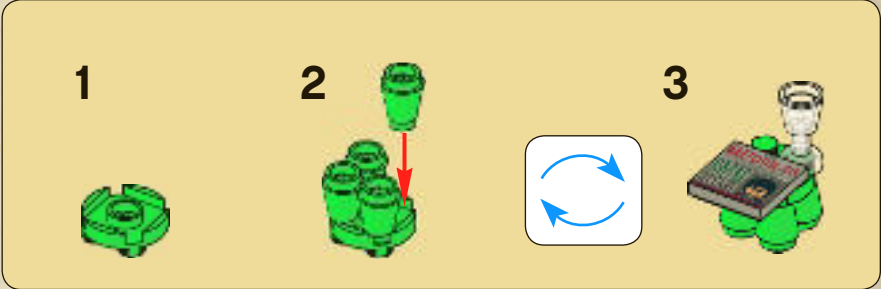

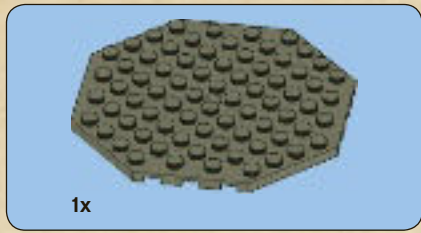

13

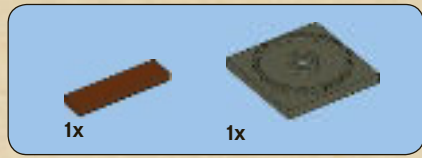

14



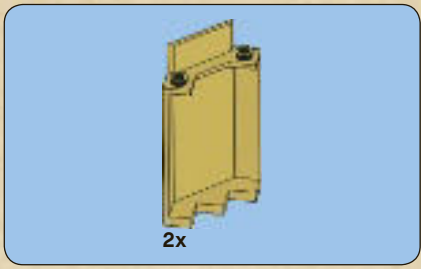

15

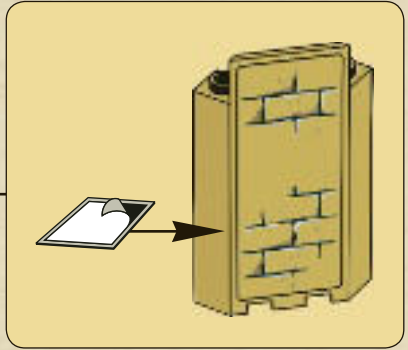
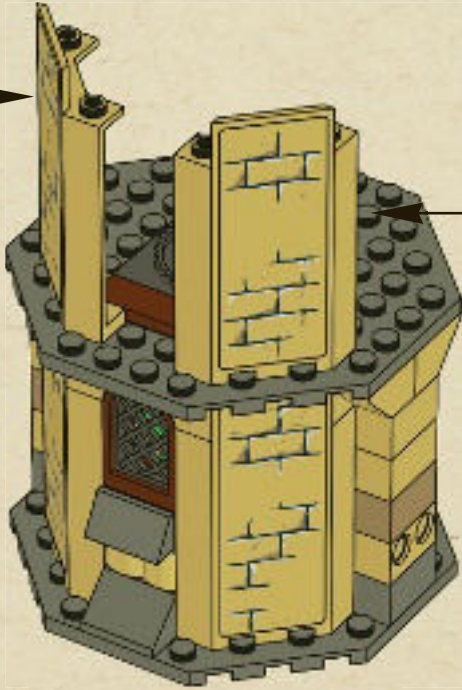
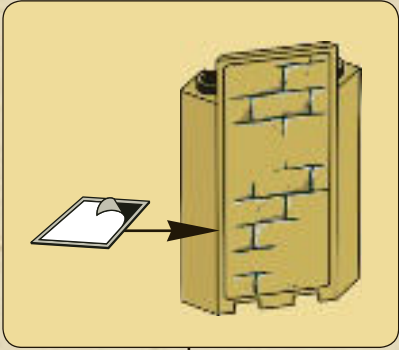

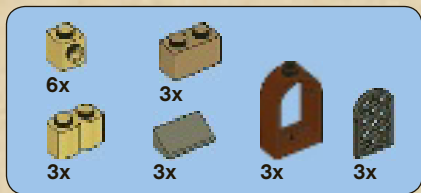

# 16

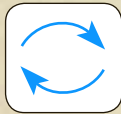
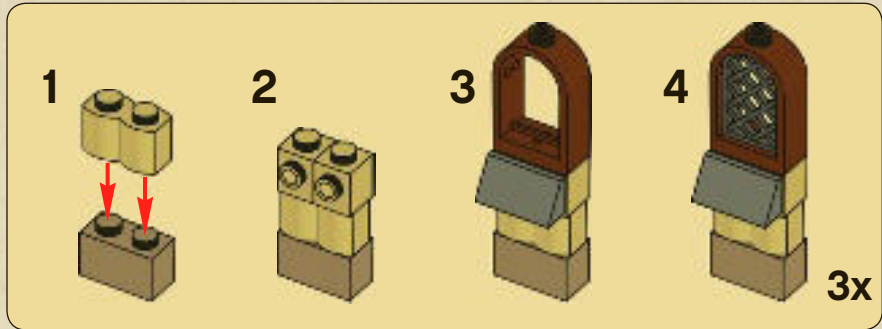



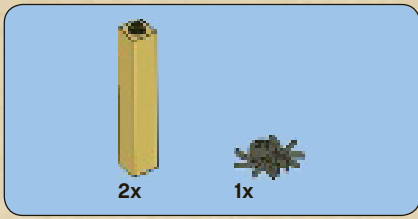

17



18





1

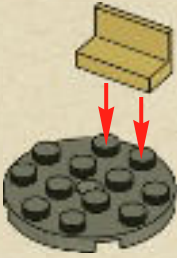

2



3



4





5



6

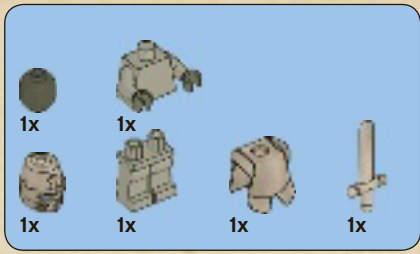
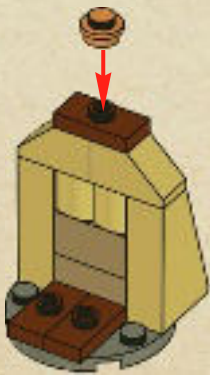

7

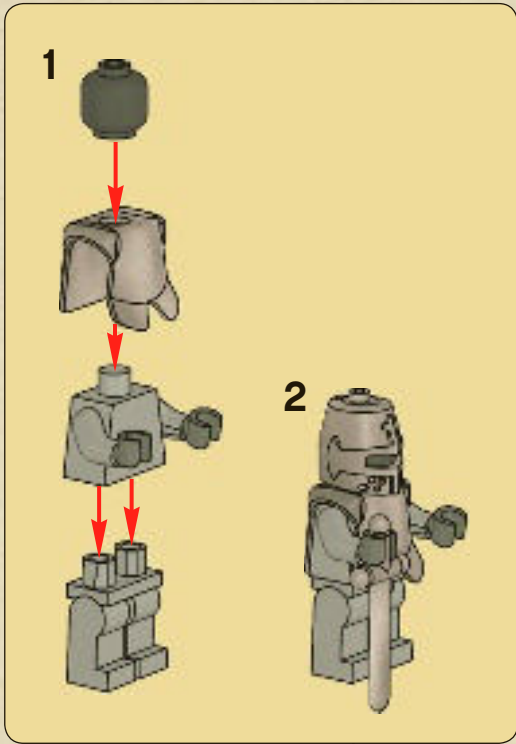



1x

8



19



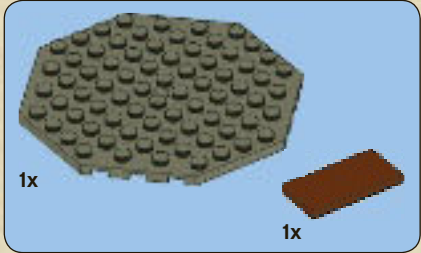

1

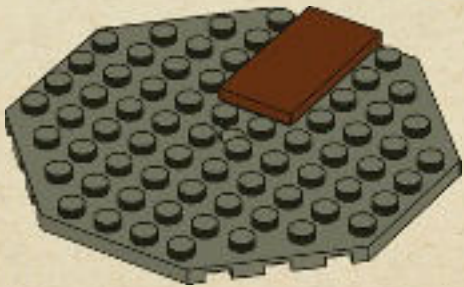

2

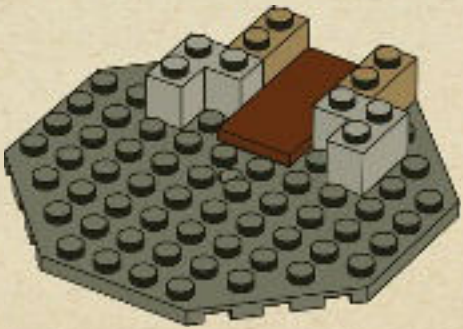

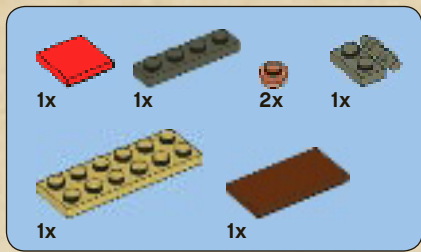

# 3

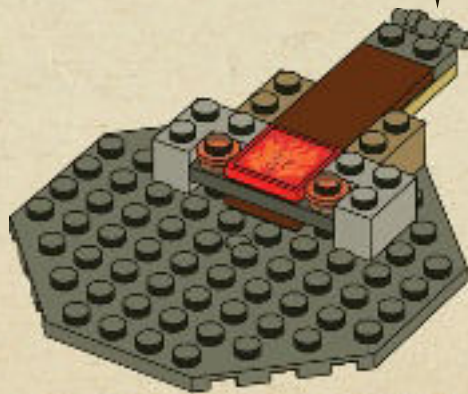
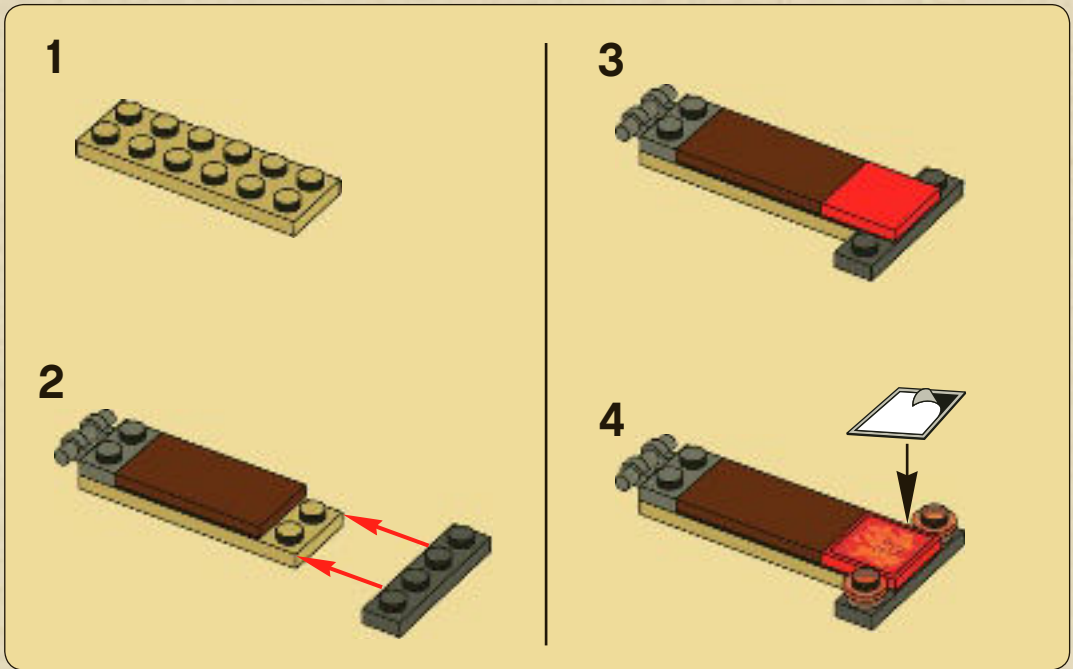



4

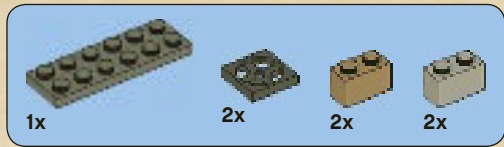
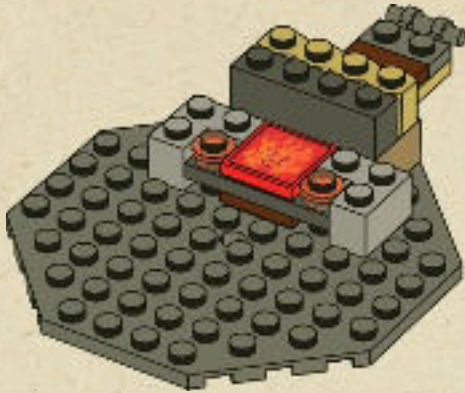

6

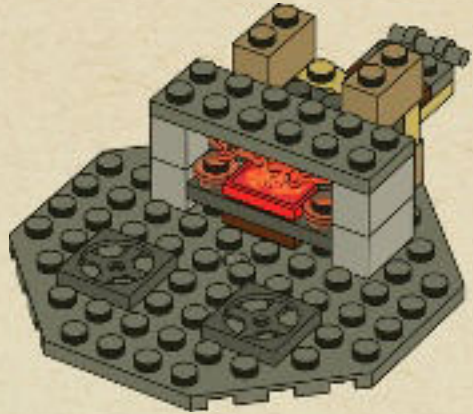

5

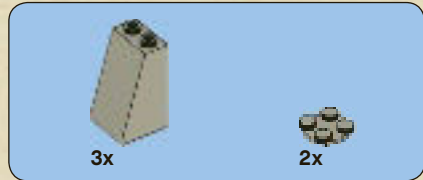
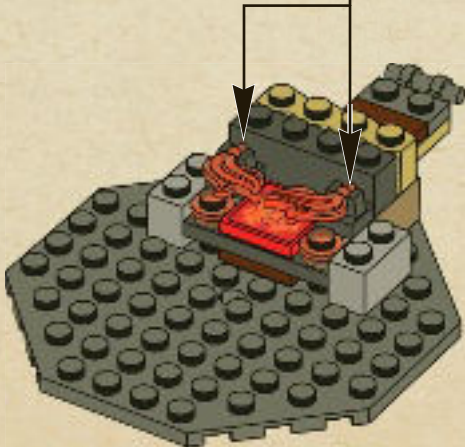

7

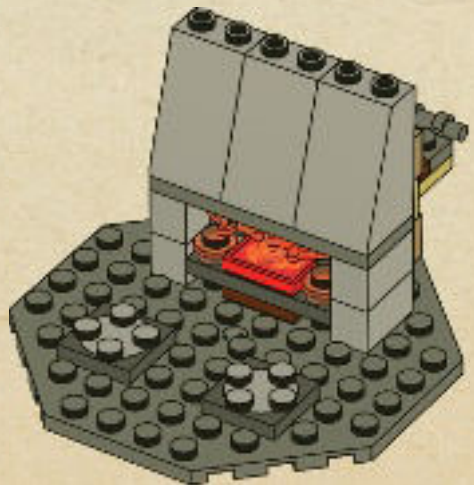



8

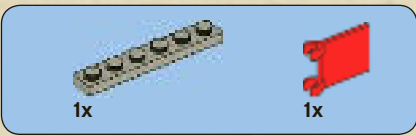
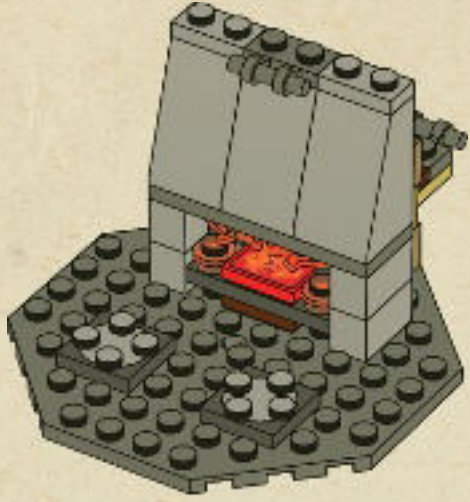

9

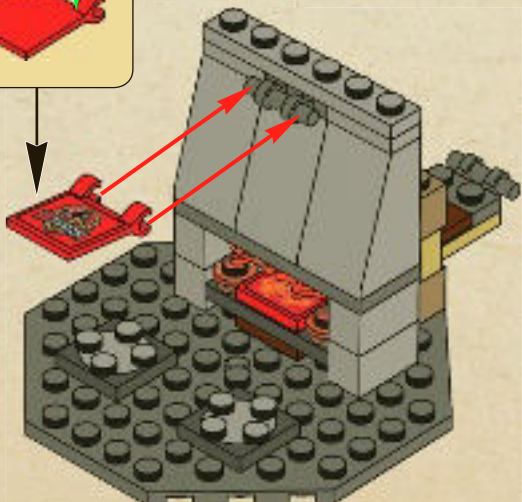

10

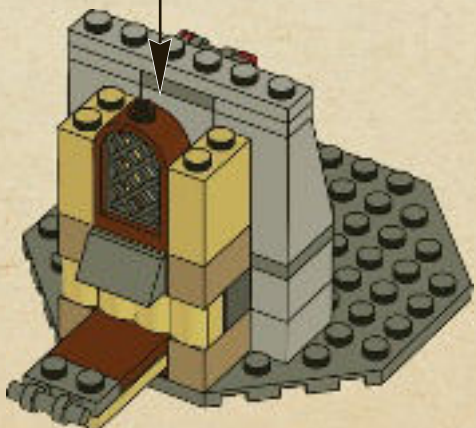
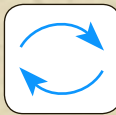
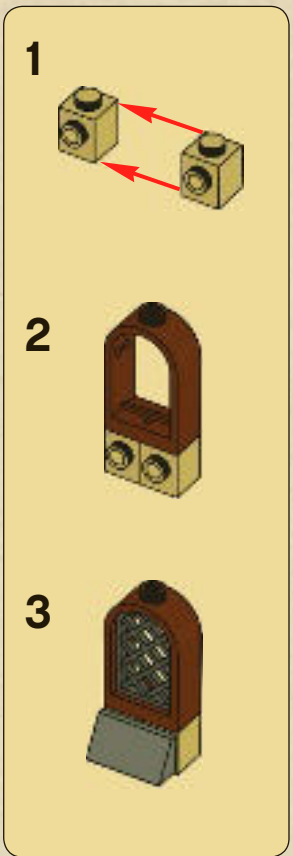



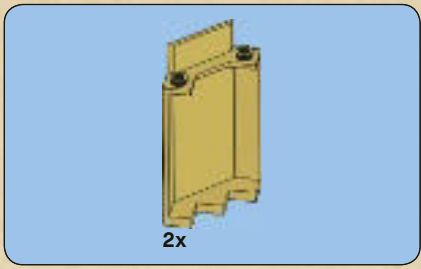

11

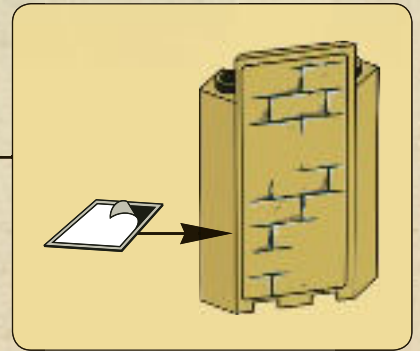
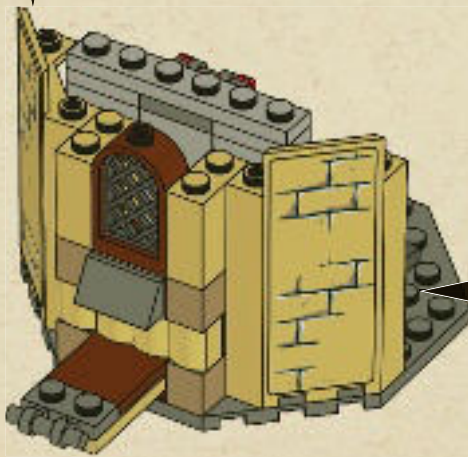
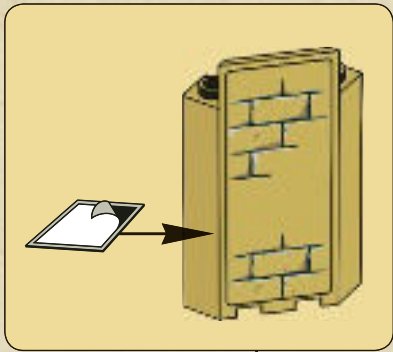



2x

# 12

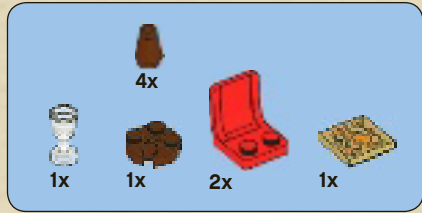
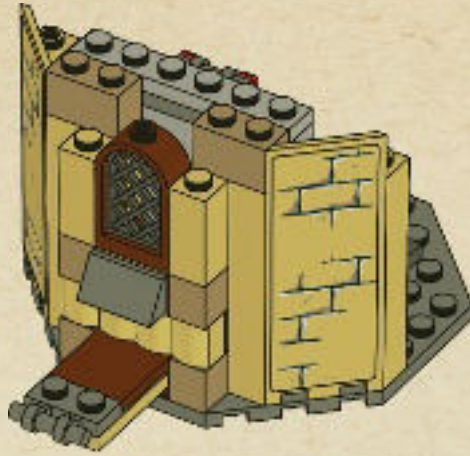

# 13



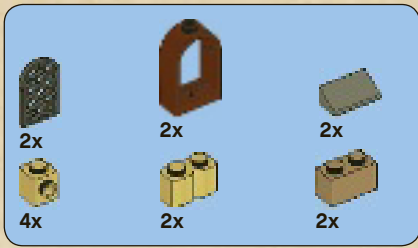

# 14

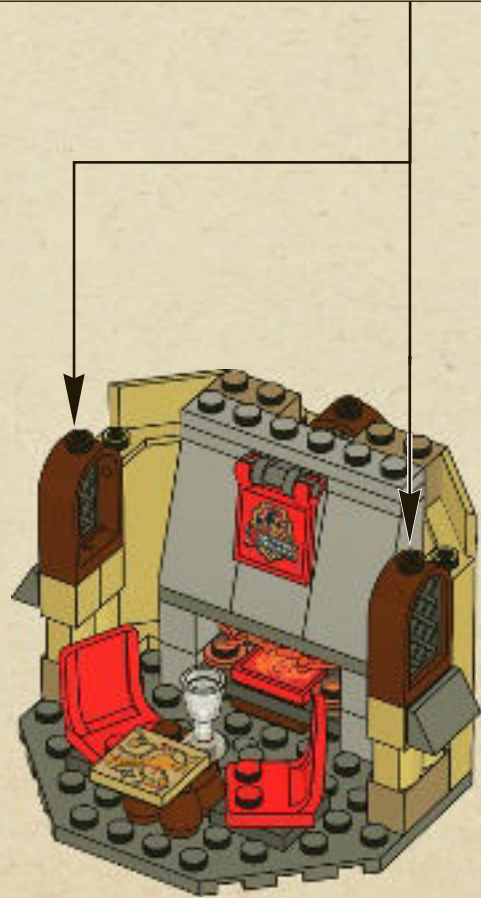
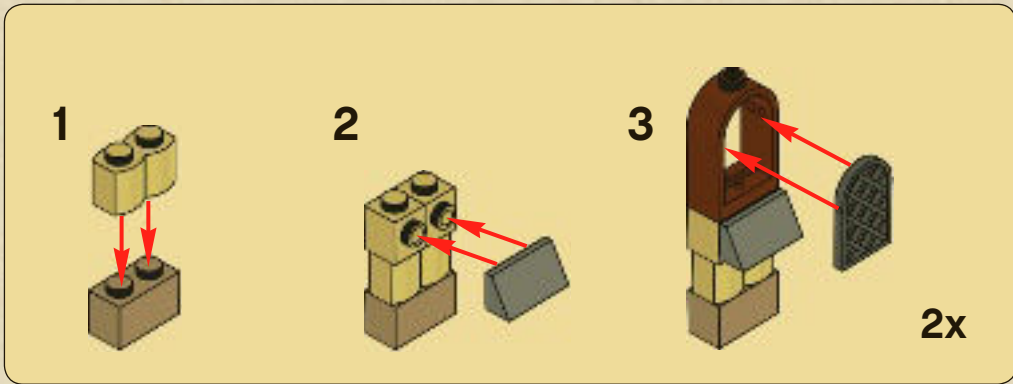



2x

15



3x

16

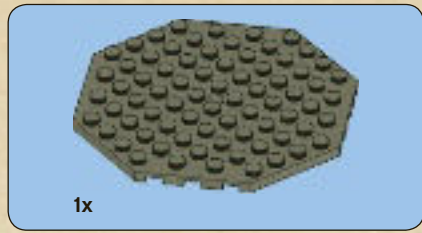

1x

17





18

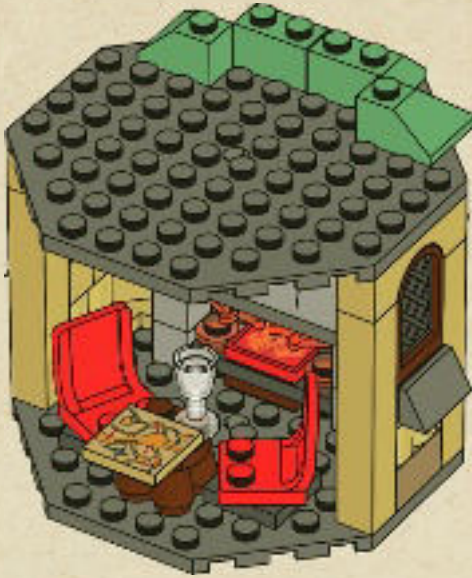

19



20





21

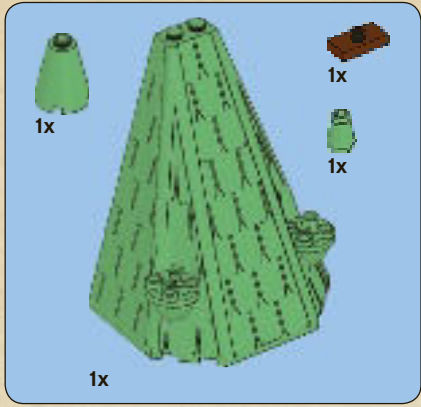

22

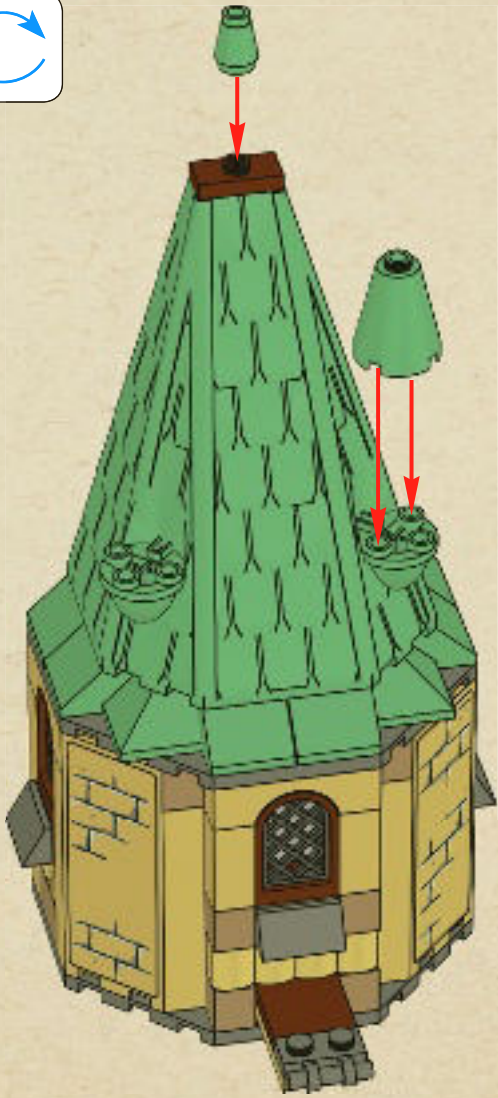



1



2

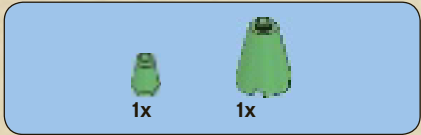
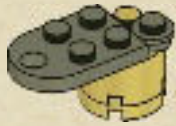

3

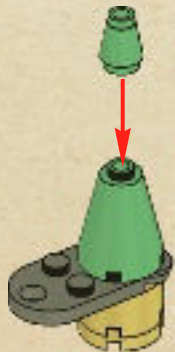

4

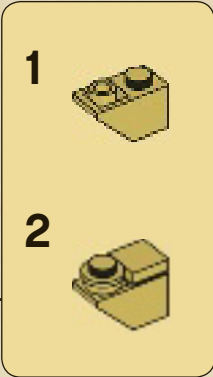
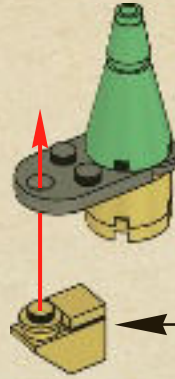

5

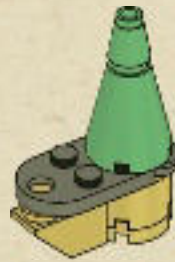

2x

6

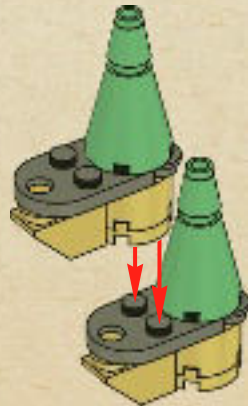



7

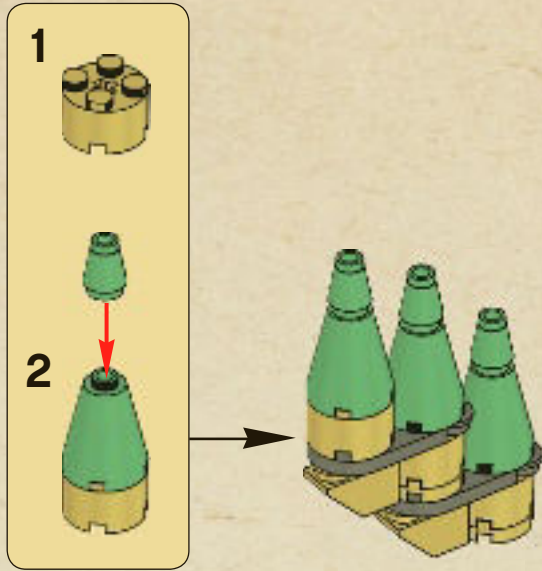

23





24



25

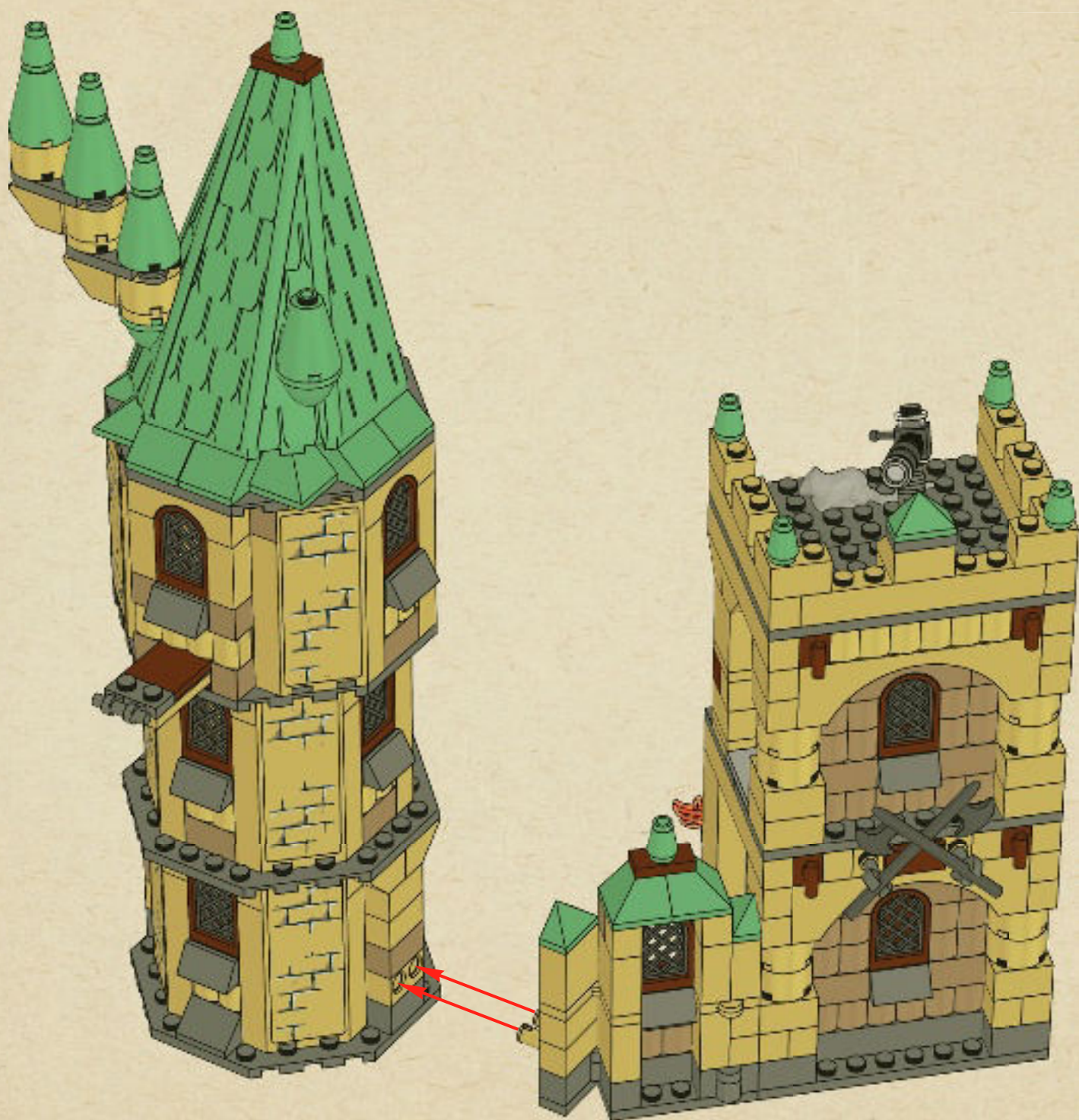

26

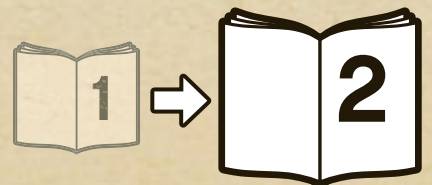



# Harry Potter

YEARS 1-4



[WWW.MAGICISBUILDING.COM](http://WWW.MAGICISBUILDING.COM)

Wii

NINTENDO DS



PlayStation



Games for Windows



XBOX 360

RATING PENDING  
RP  
CONTENT RATED BY  
ESRB

Visit [www.esrb.org](http://www.esrb.org)  
for rating information

LEGO HARRY POTTER YEARS 1-4 is based on the Harry Potter books by J.K. Rowling. LEGO HARRY POTTER YEARS 1-4 is a trademark of The LEGO Group. LEGO, the LEGO logo, the Brick and the Knob configurations and the Minifigure are trademarks of the LEGO Group. © 2010 The LEGO Group. PlayStation and the PS Family logo are registered trademarks of Sony Computer Entertainment Inc. Wii and Nintendo DS are trademarks of Nintendo. © 2010 Microsoft, Xbox, Xbox 360, Game LIVE and the Xbox logo are trademarks of the Microsoft group of companies and are used under license from Microsoft. Windows Live is a trademark of the Microsoft group of companies and "Start for Windows" and the Windows + Start logo are used under license from Microsoft. All other trademarks and copyrights are the property of their respective owners. All rights reserved.



LEGO HARRY POTTER is a trademark of Warner Bros. Entertainment Inc. Harry Potter Publishing Rights © 2010. WB © 2010. WB SH ELD. TM & © Warner Bros. Entertainment Inc. (12)





# Harry Potter



4842



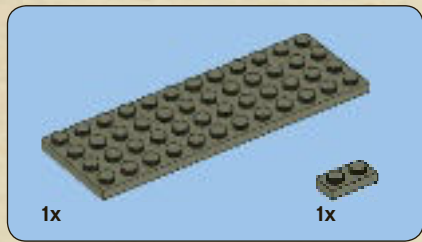
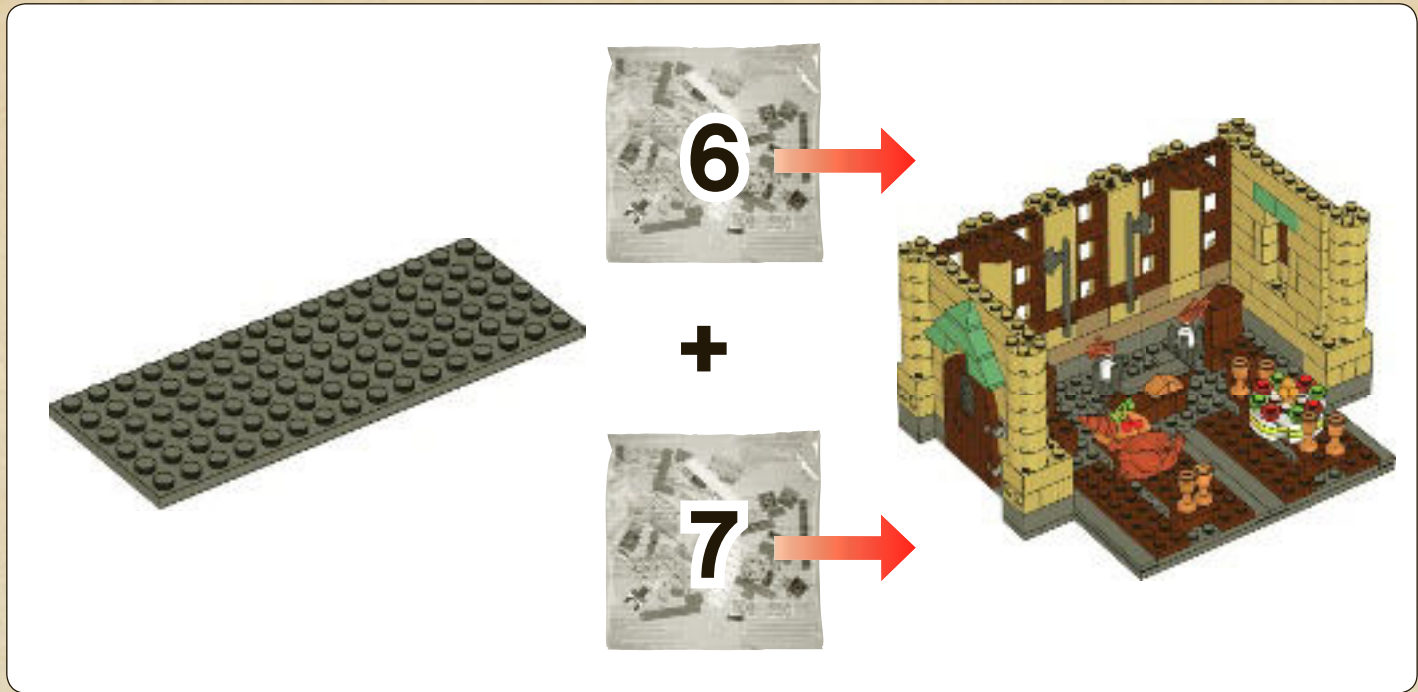

1

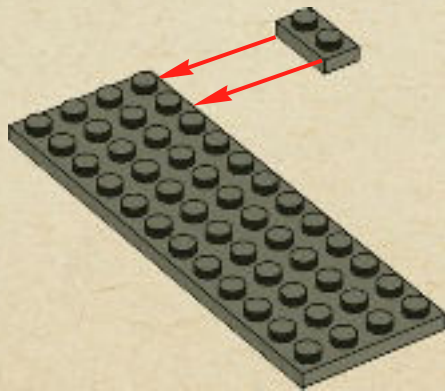



2

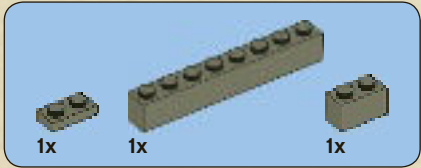
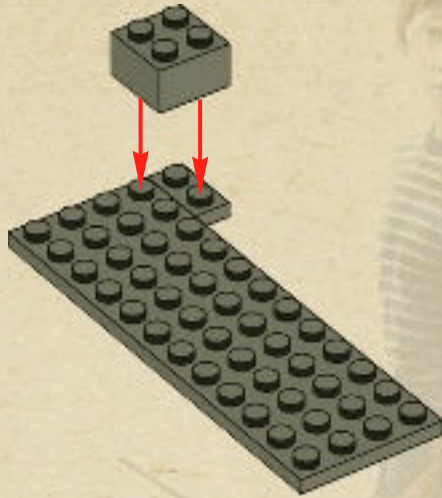

3

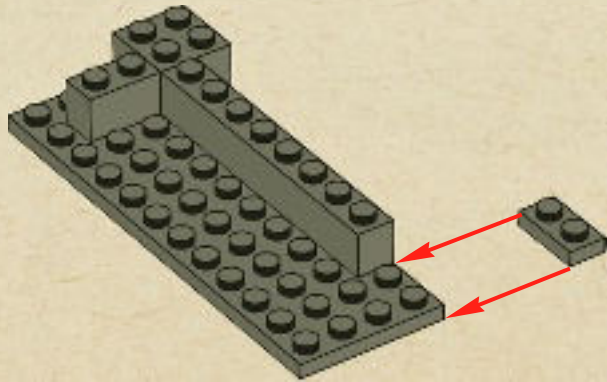

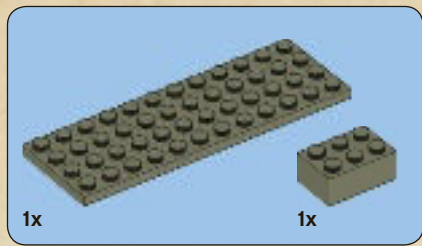

4

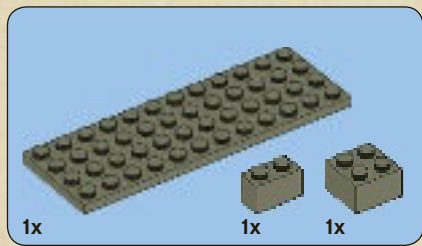
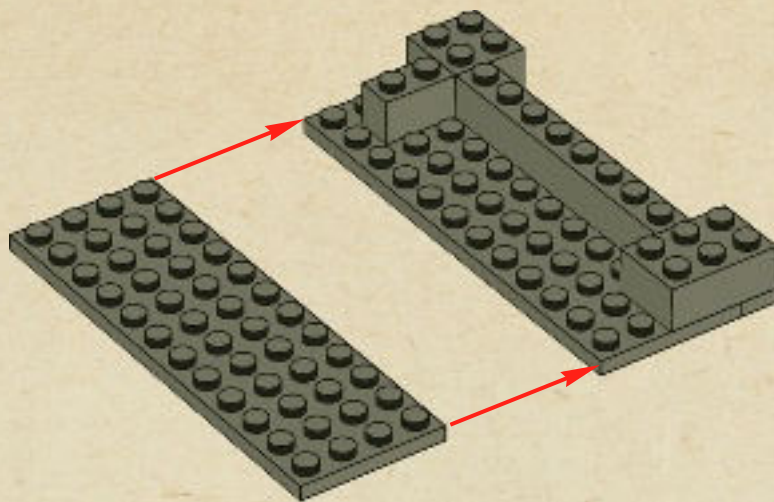

5

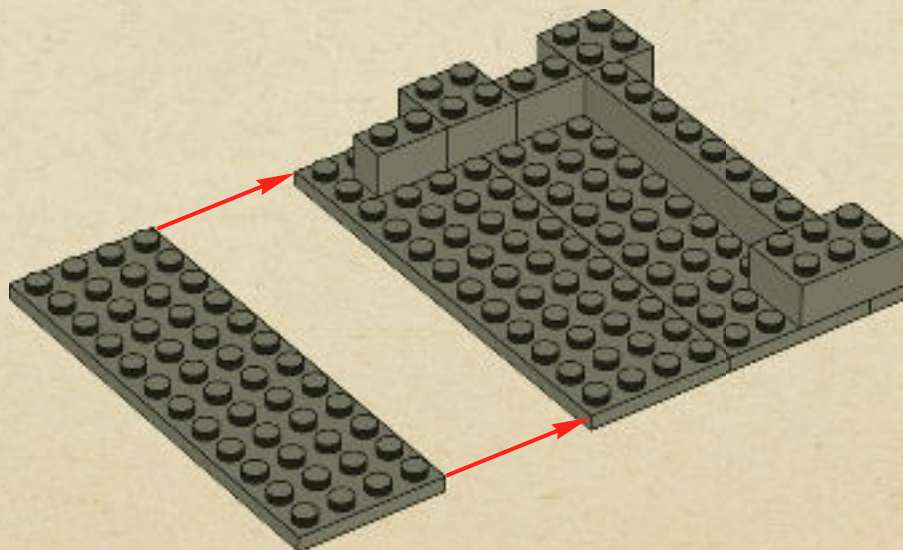





6

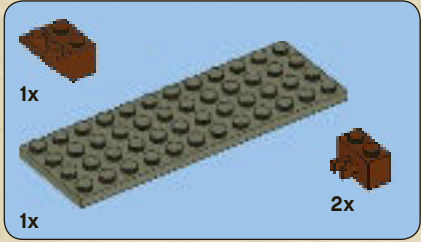
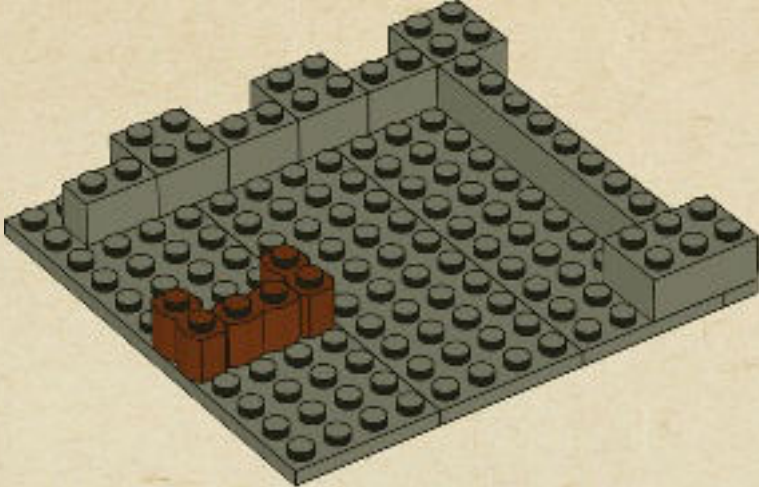

7

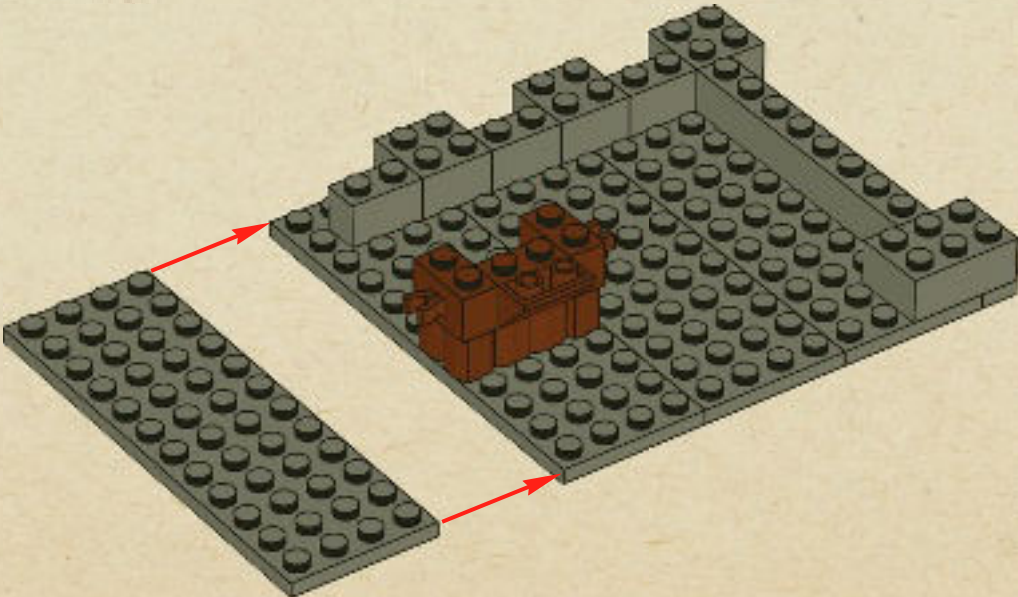

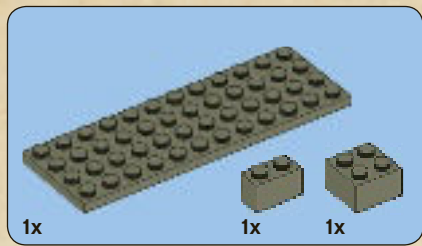

8

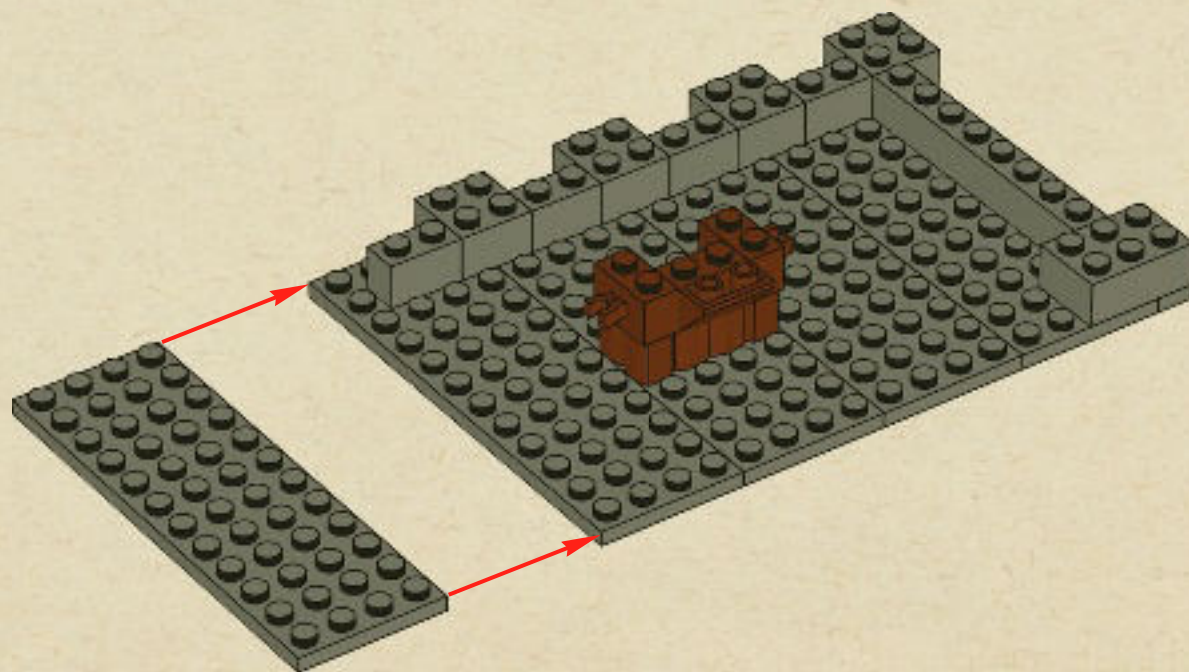



9

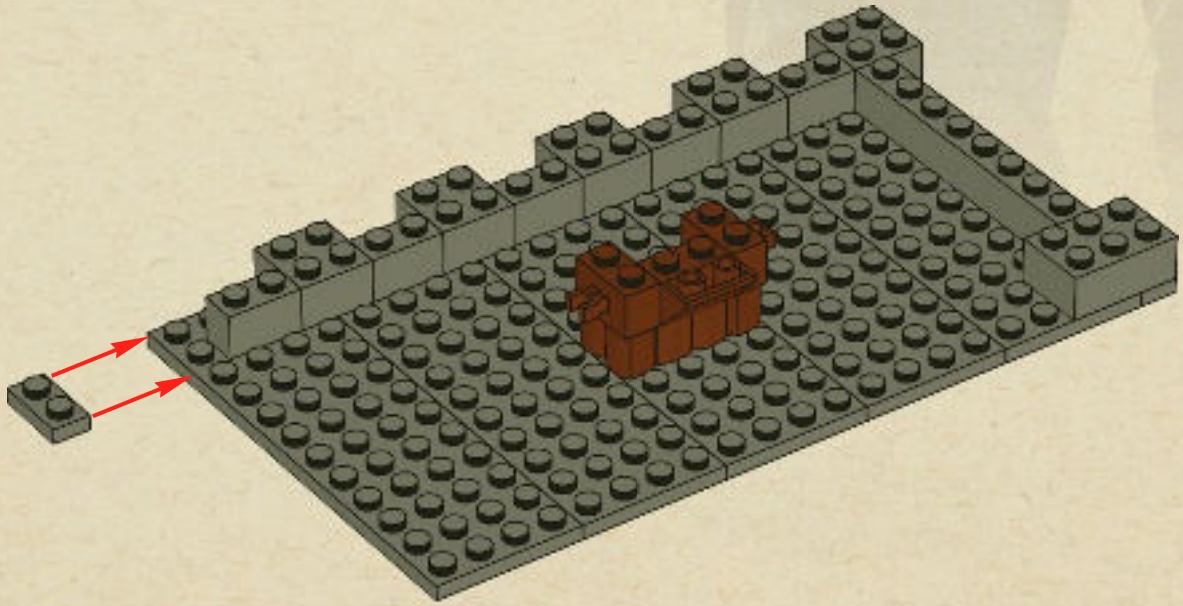

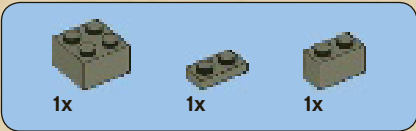

# 10

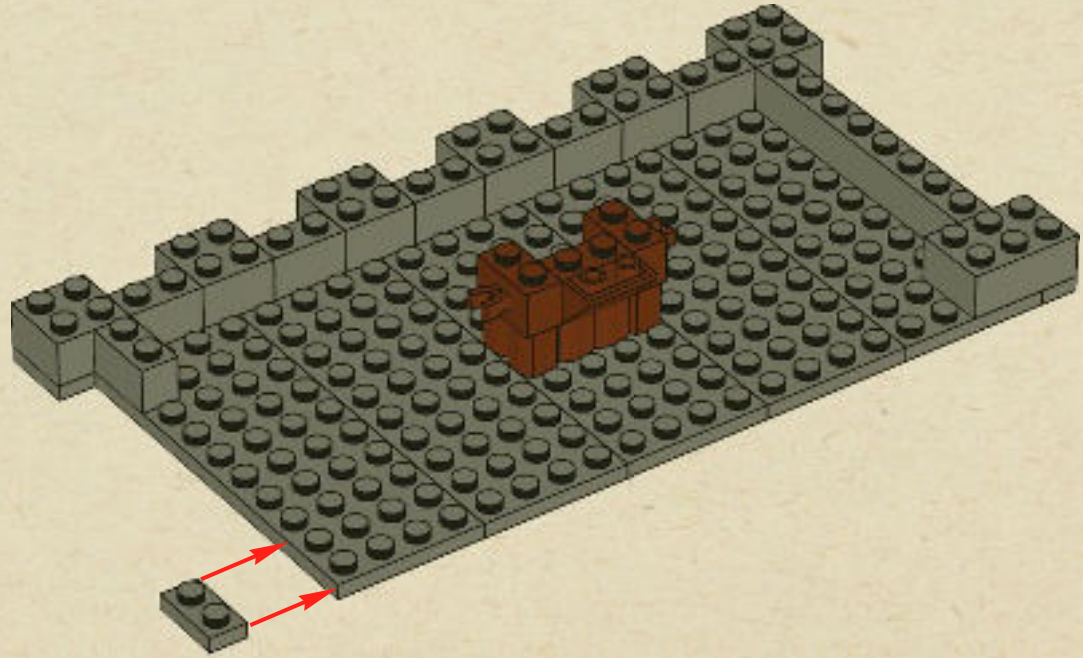



1x



1x

# 11

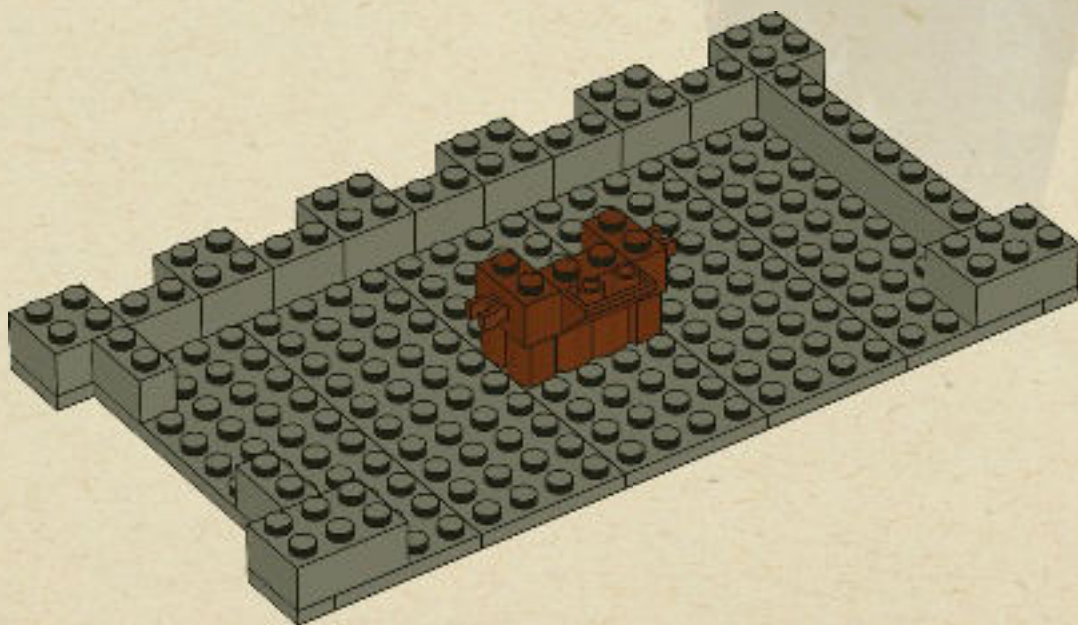

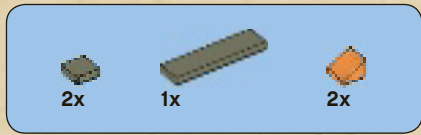

# 12

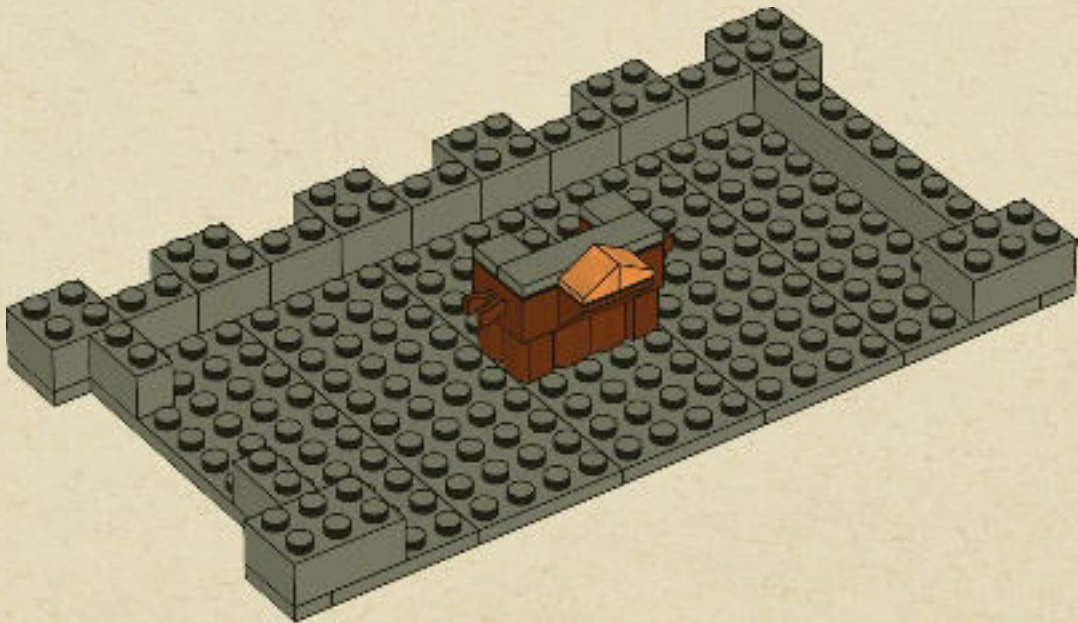



4x

# 13

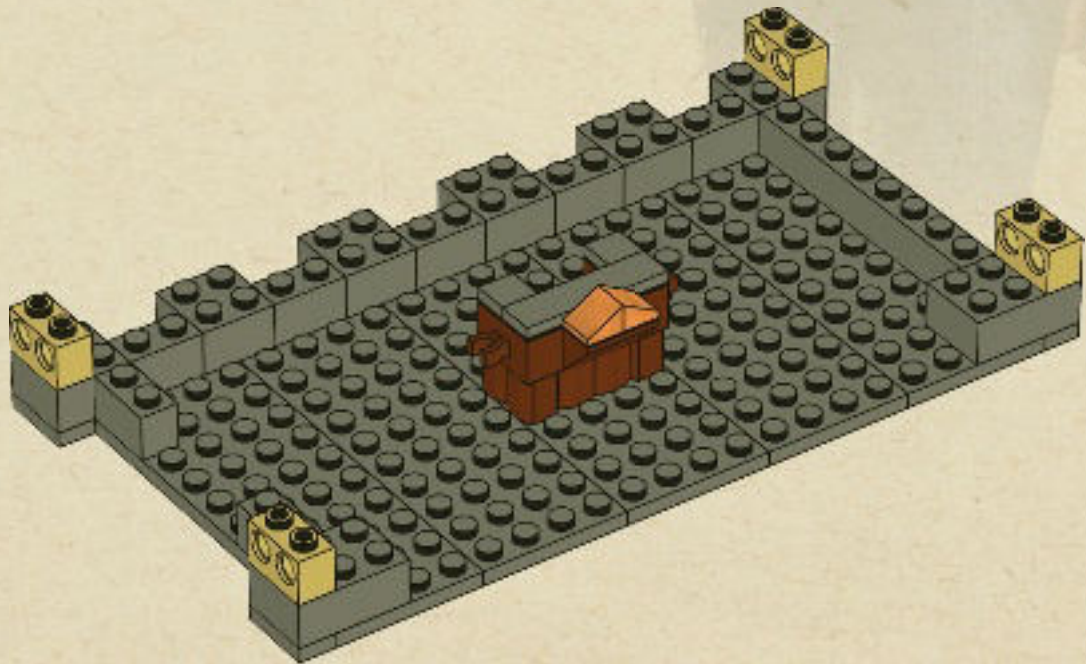

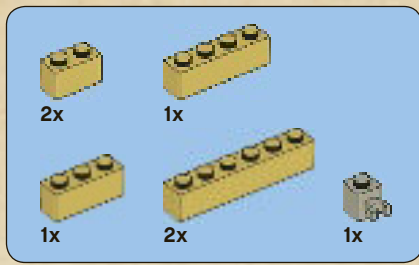

# 14

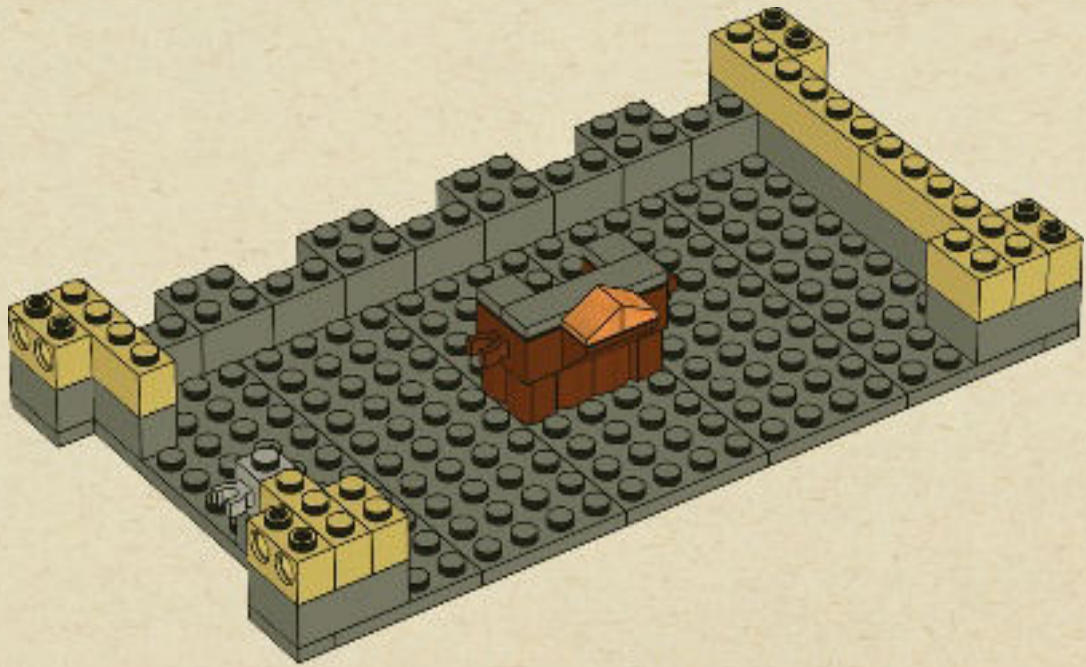



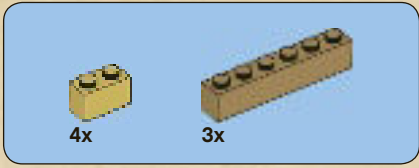

# 15

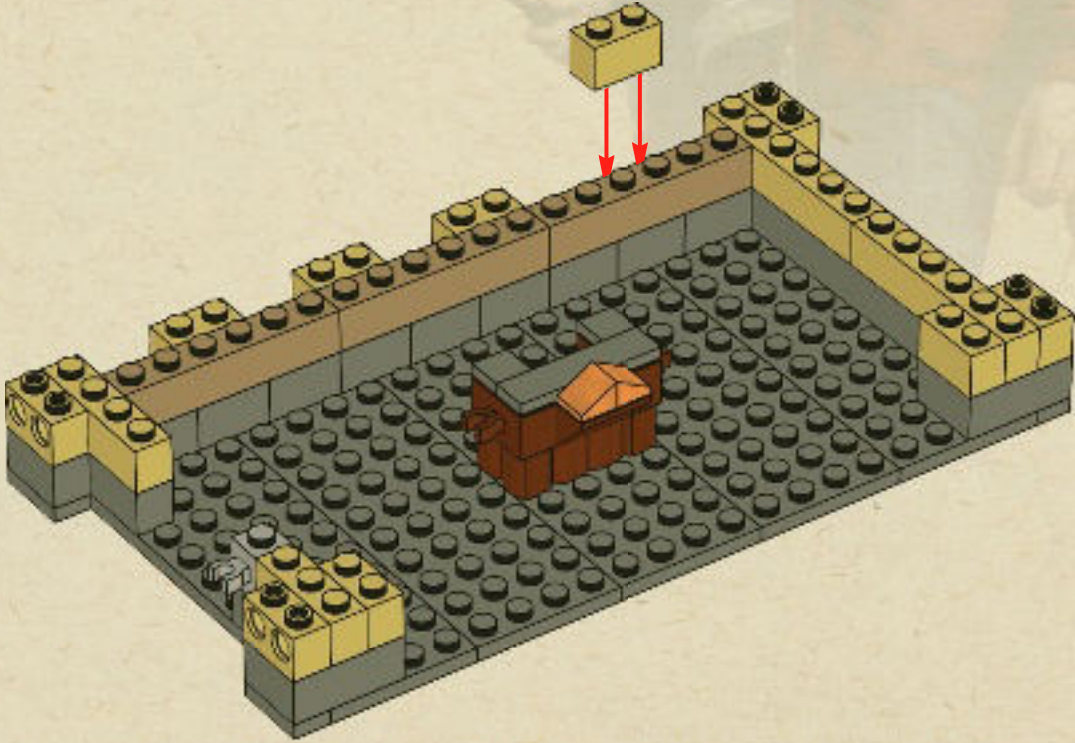

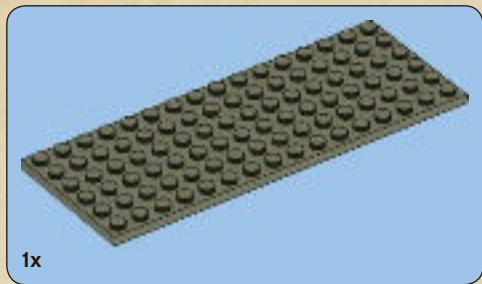

1x

# 16

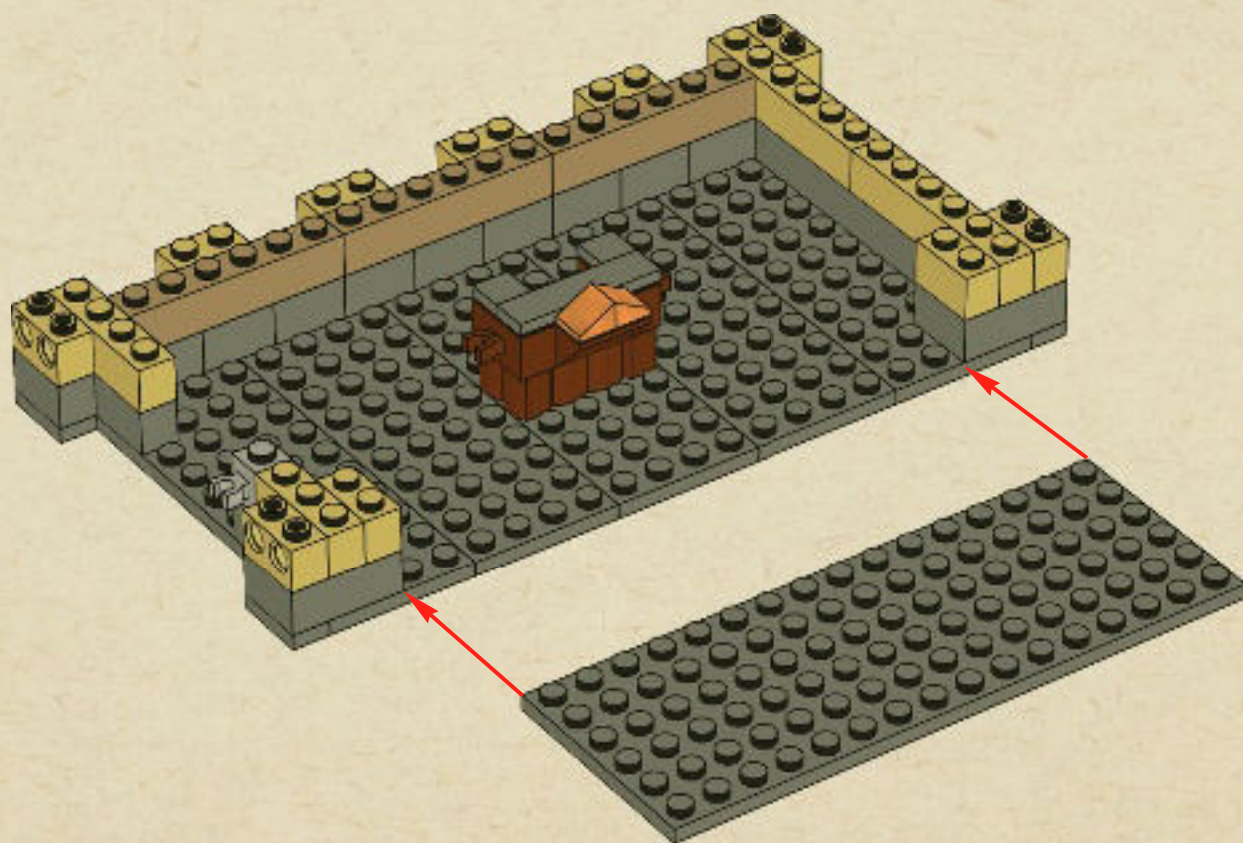

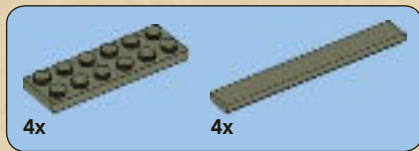

17

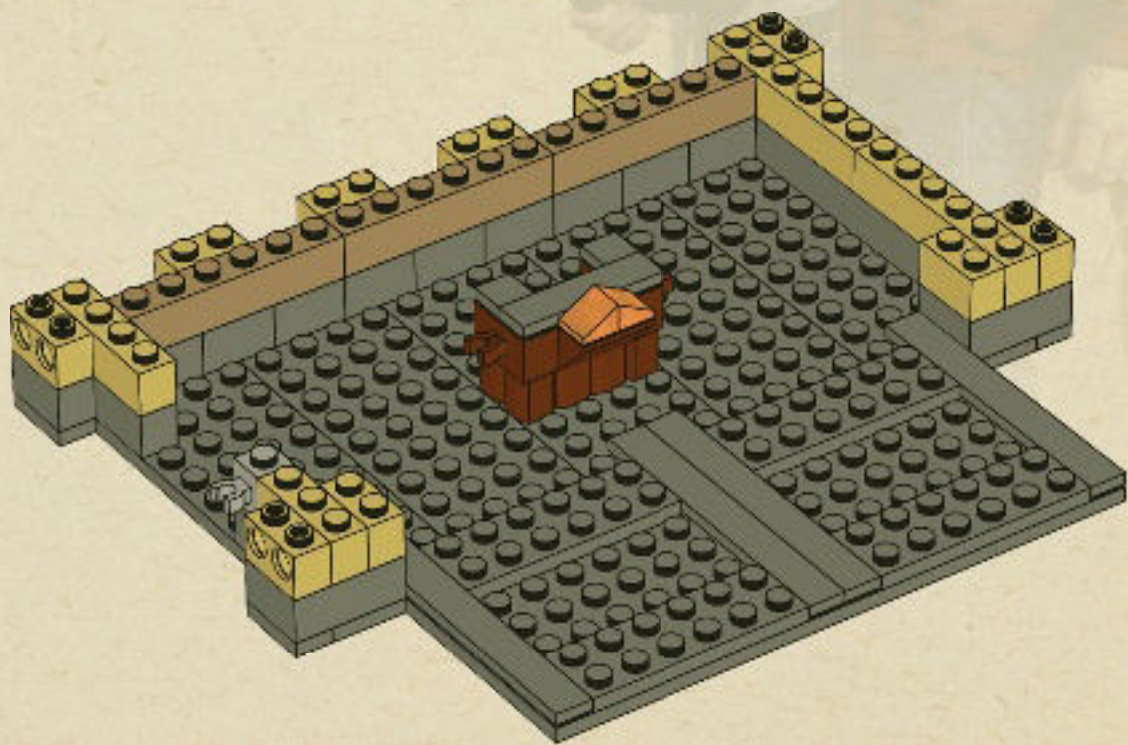

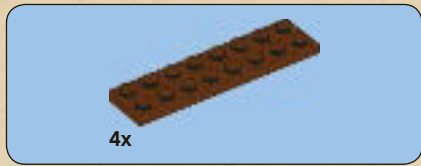

18

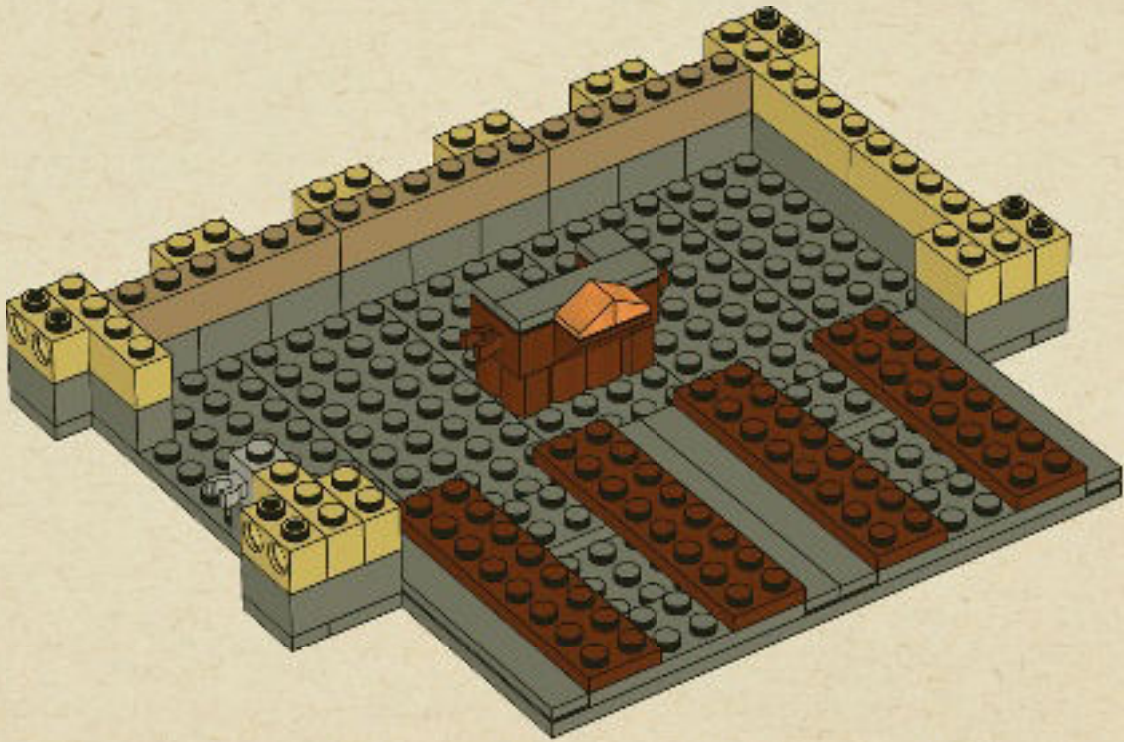



4x

# 19

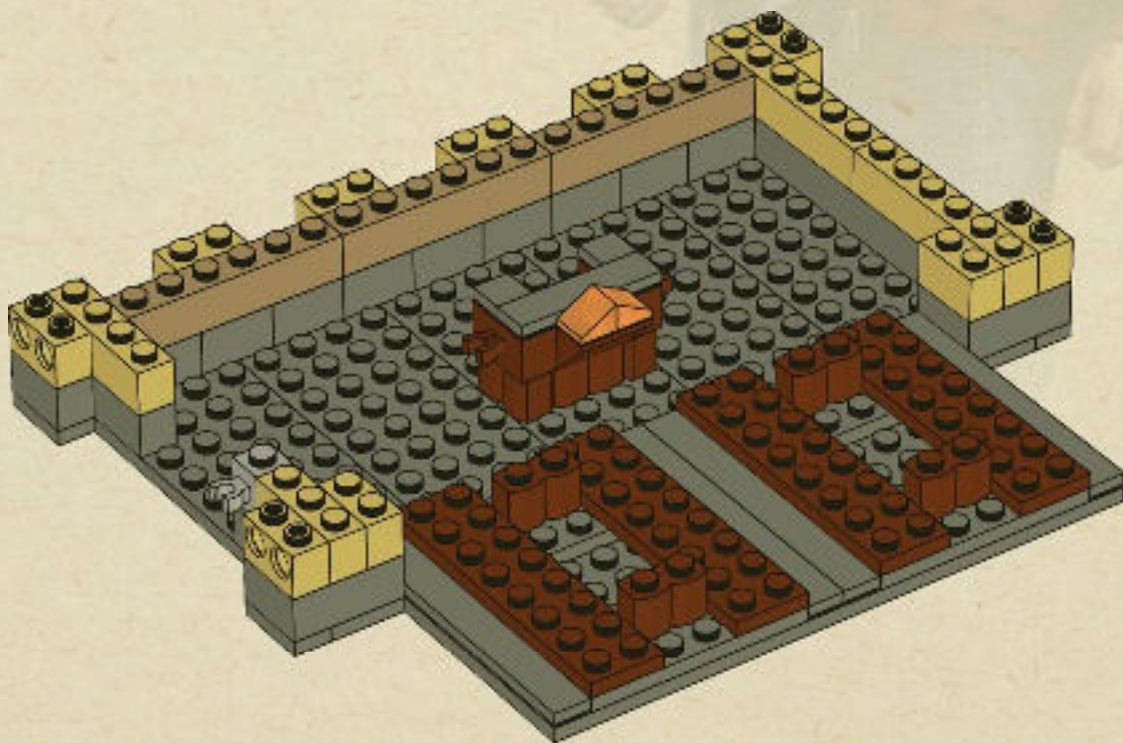

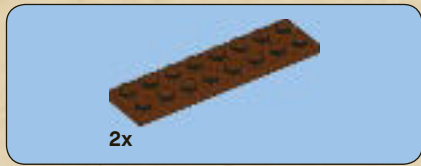

20

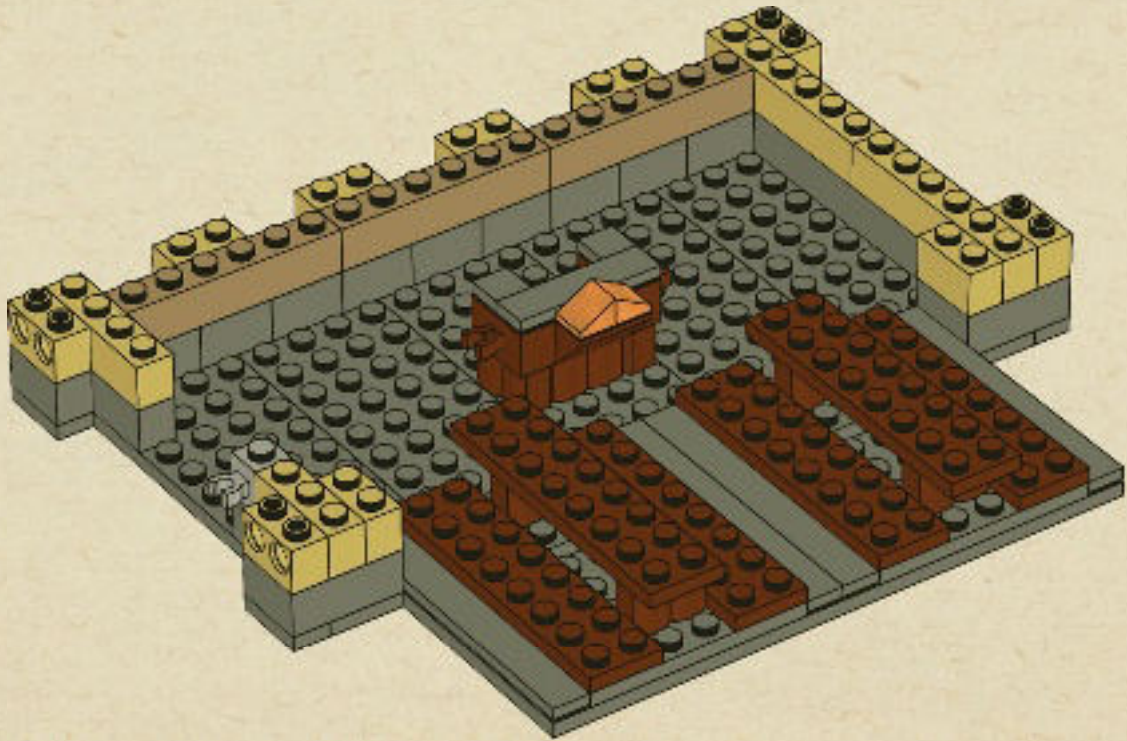



# 21

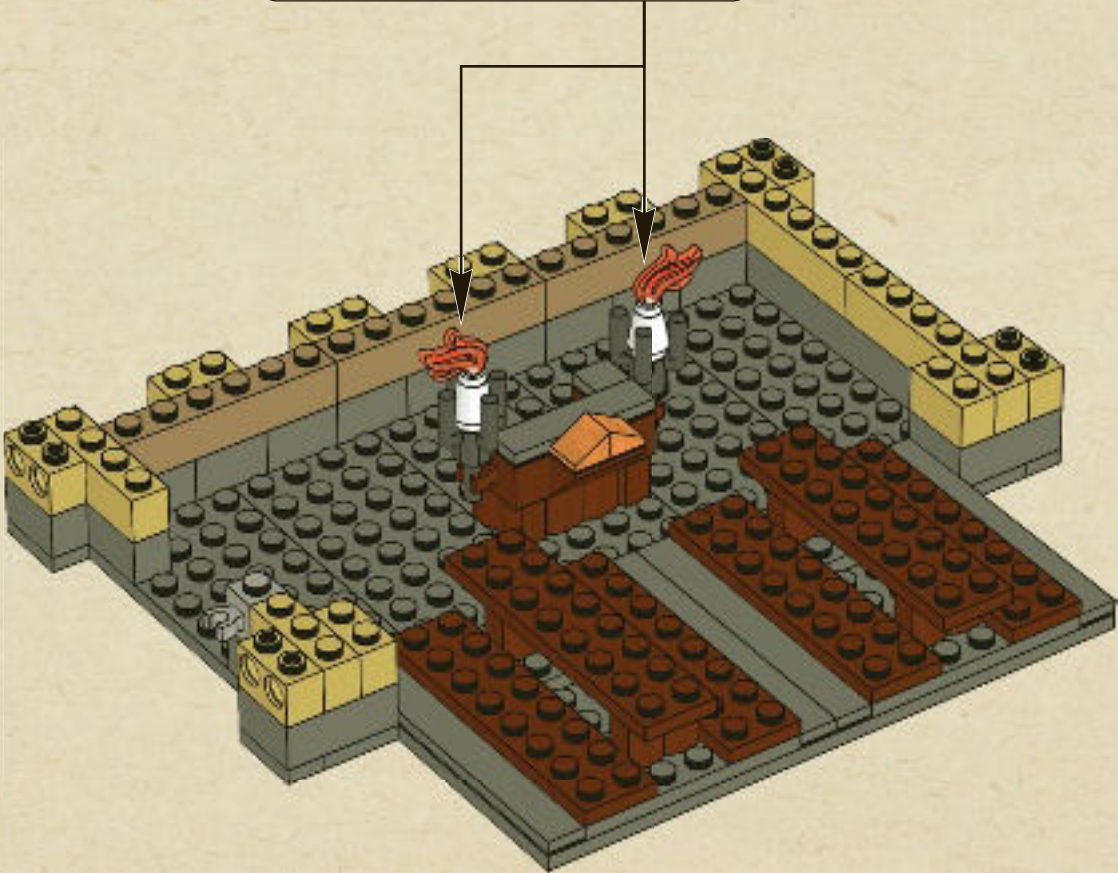
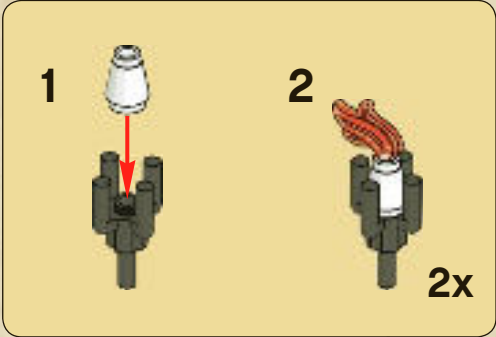



# 22

1

2

3

4

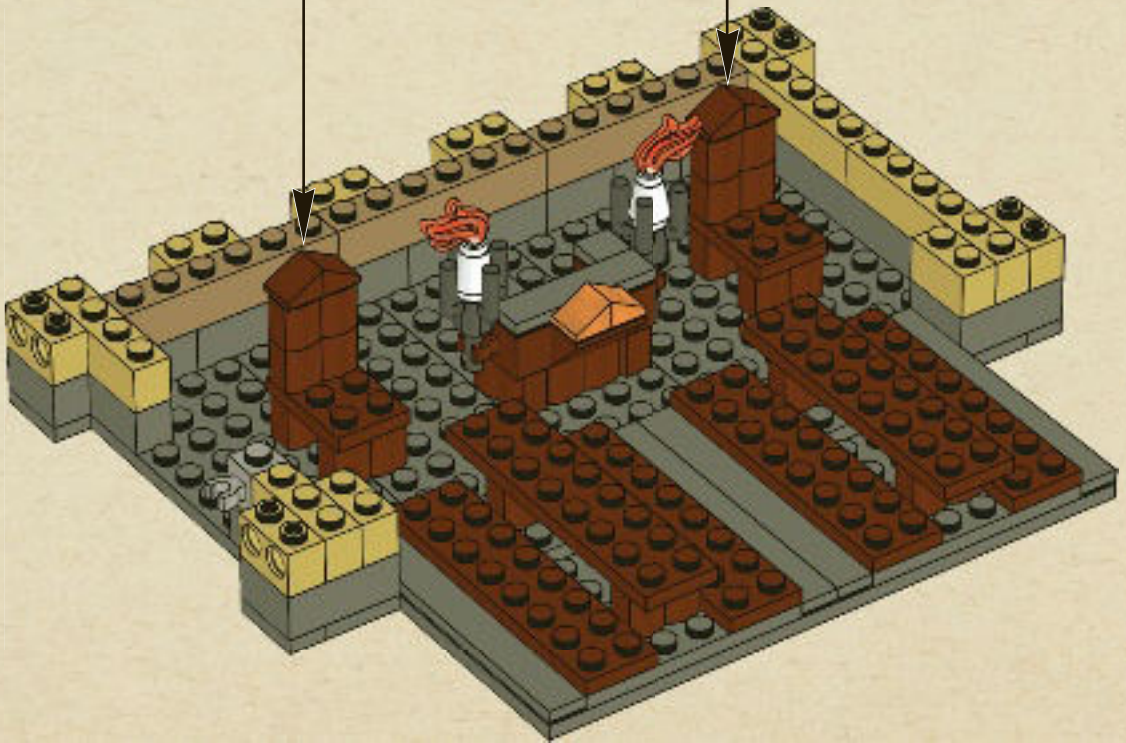





6x



5x

# 23

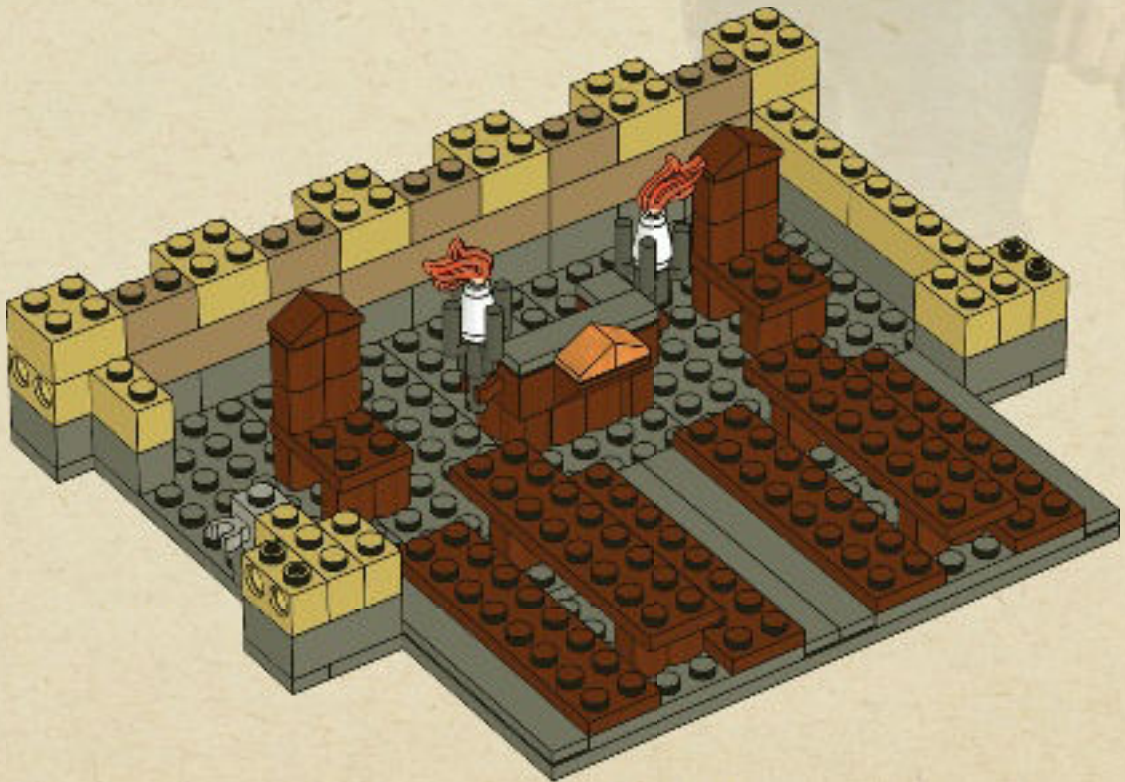

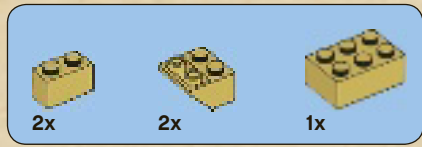

24

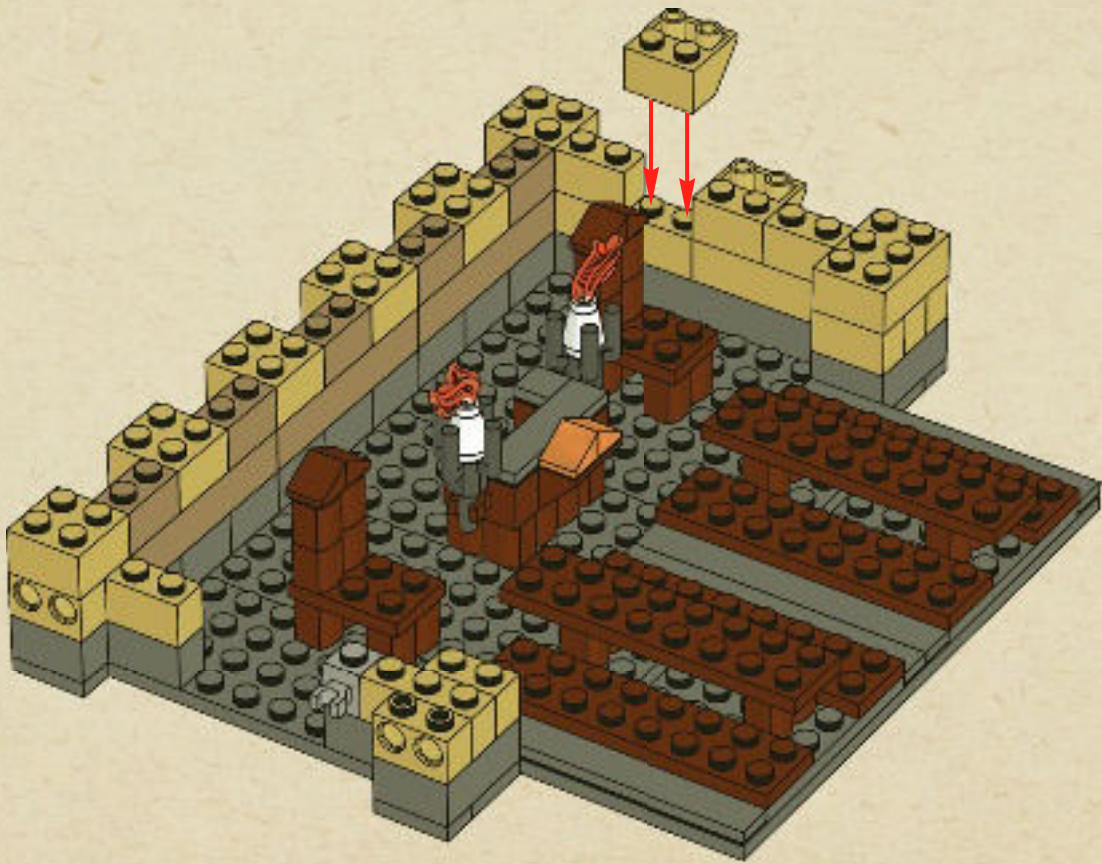



2x



1x

# 25

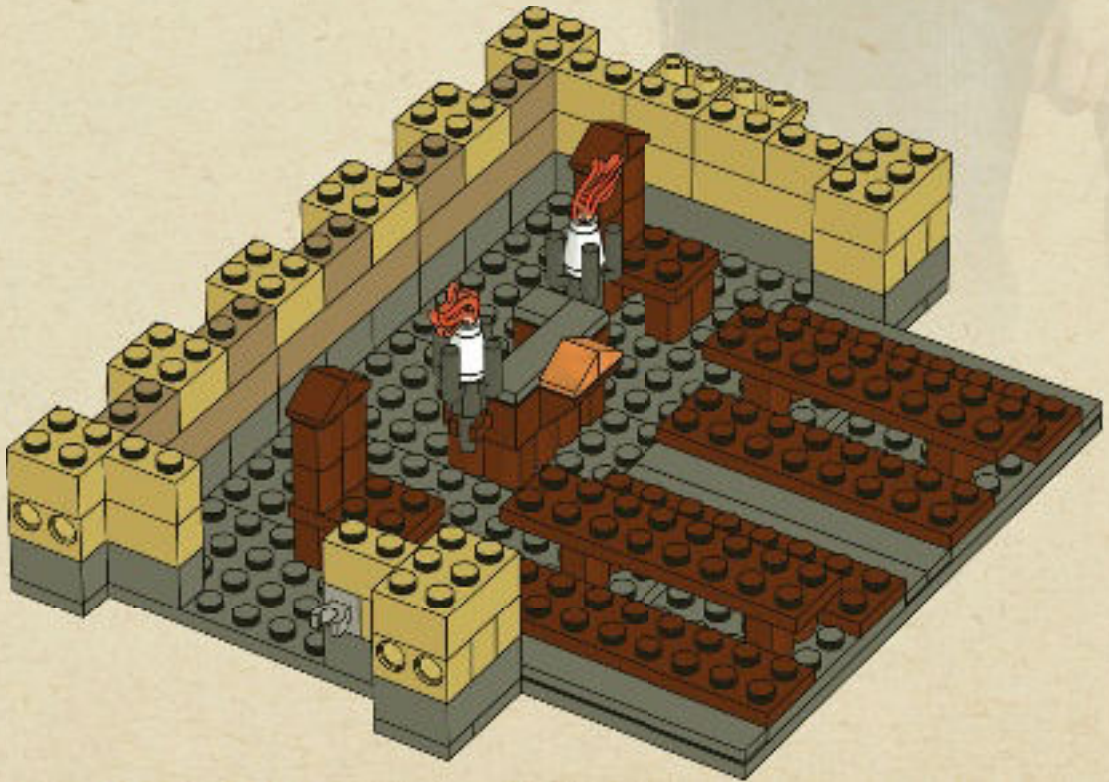



2x

# 26

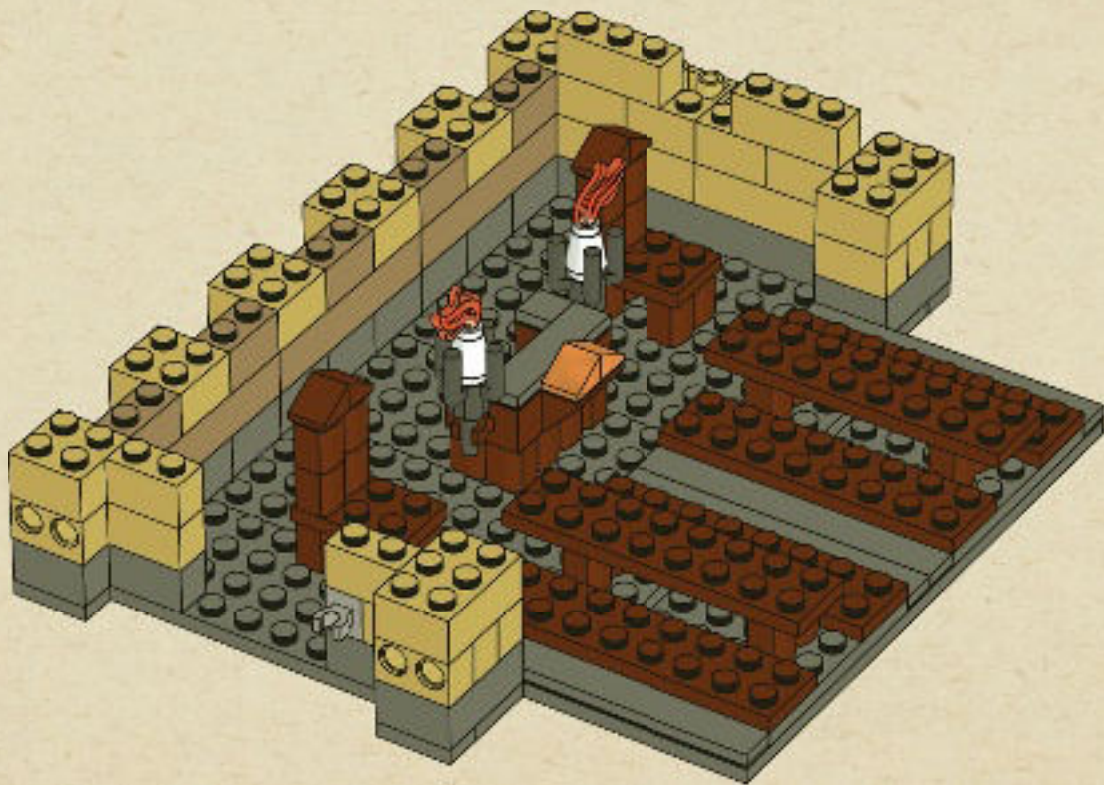



2x

27

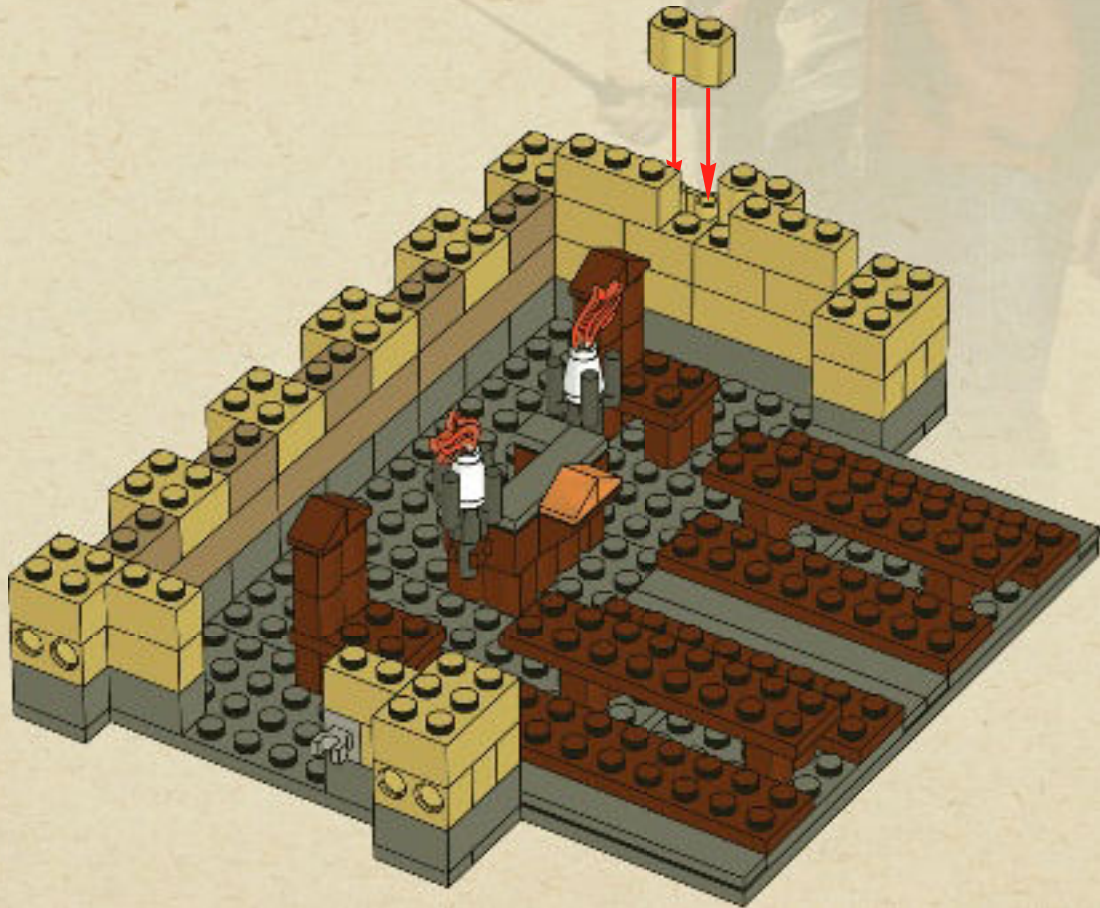



2x



2x

# 28

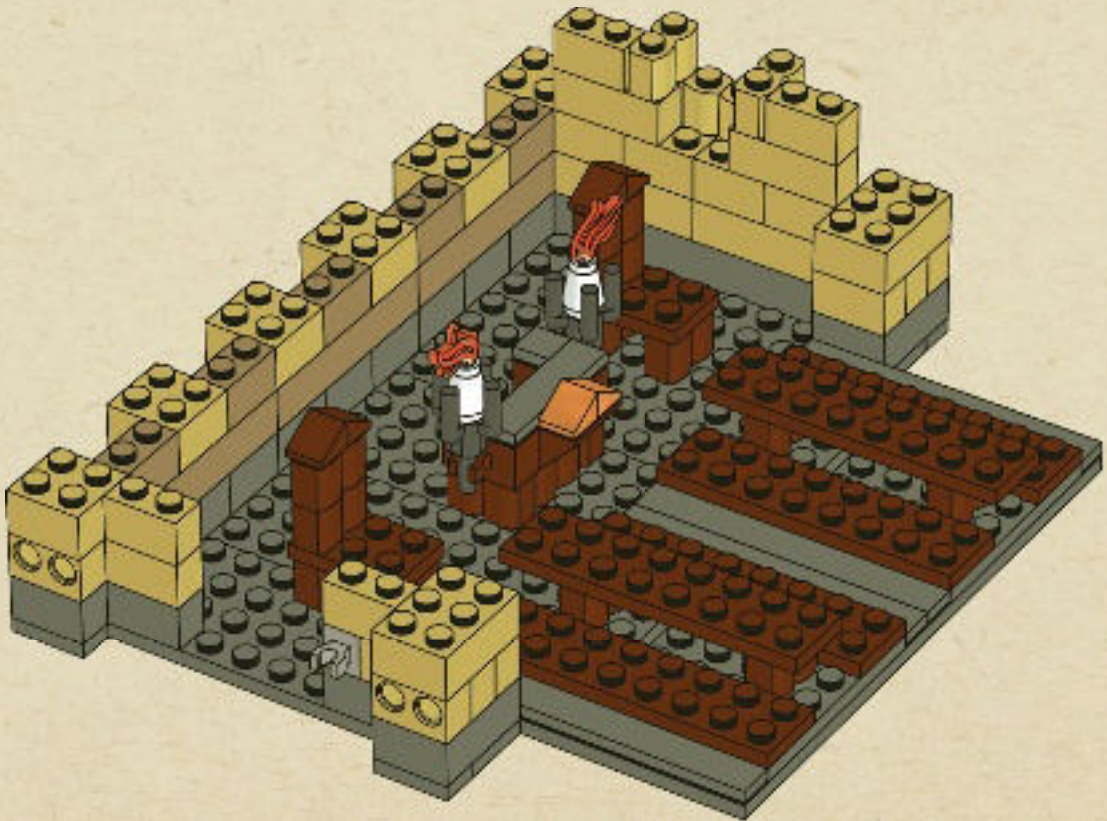

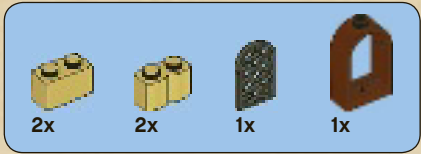

29

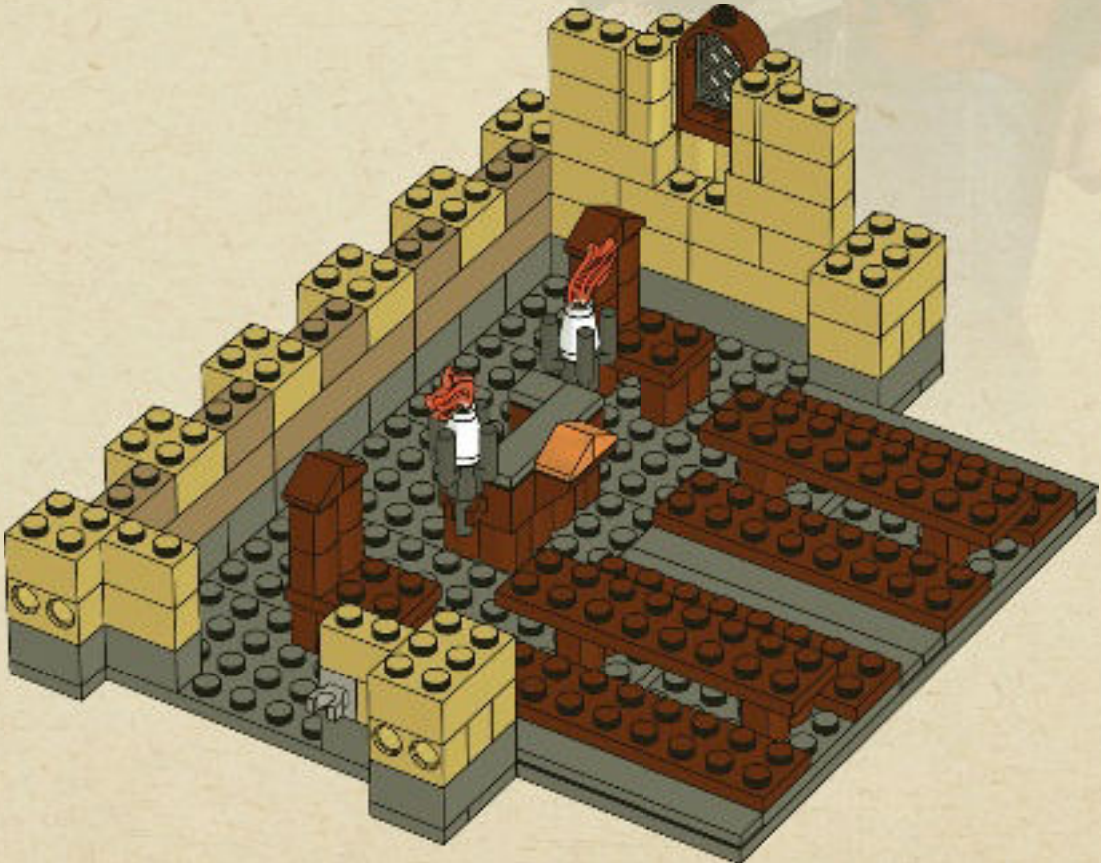

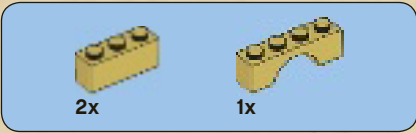

# 30

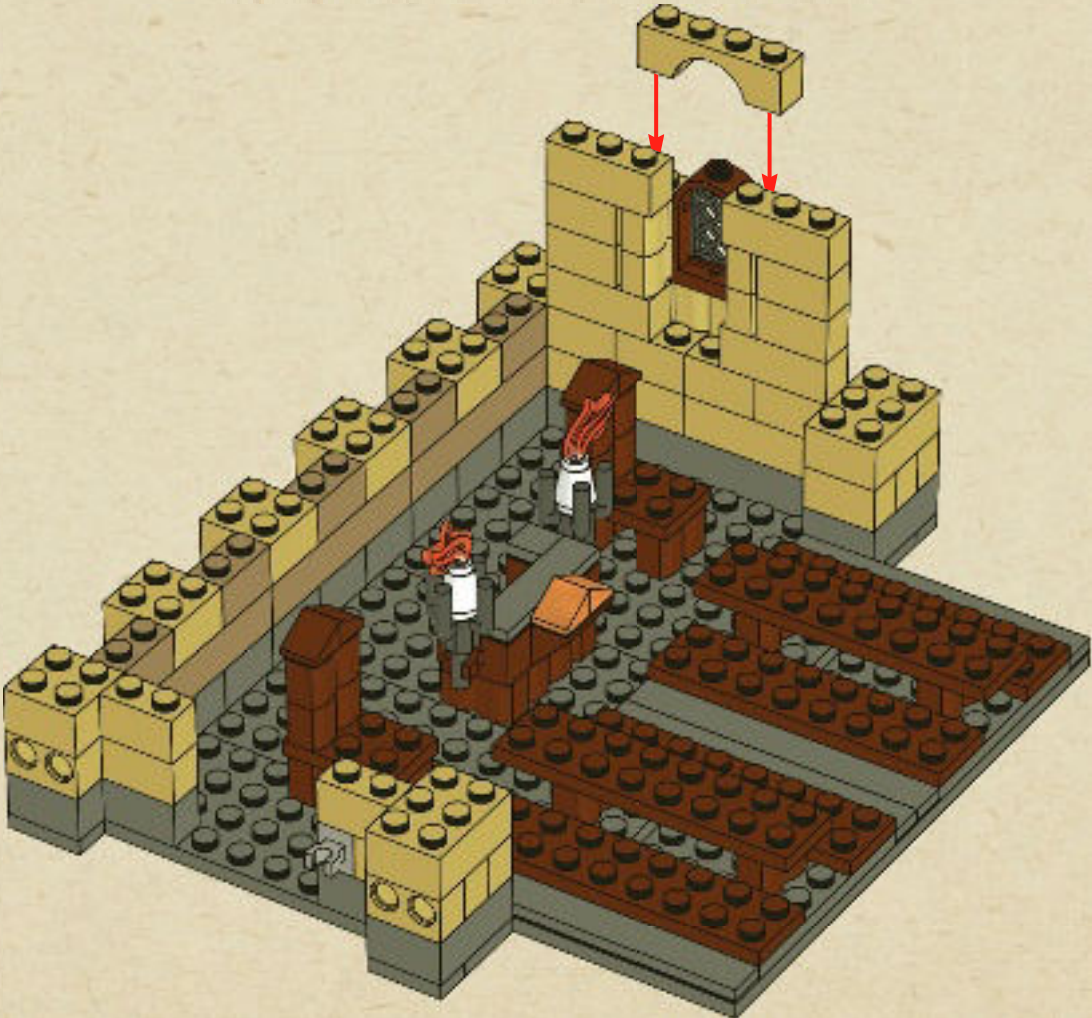





2x



2x

# 31

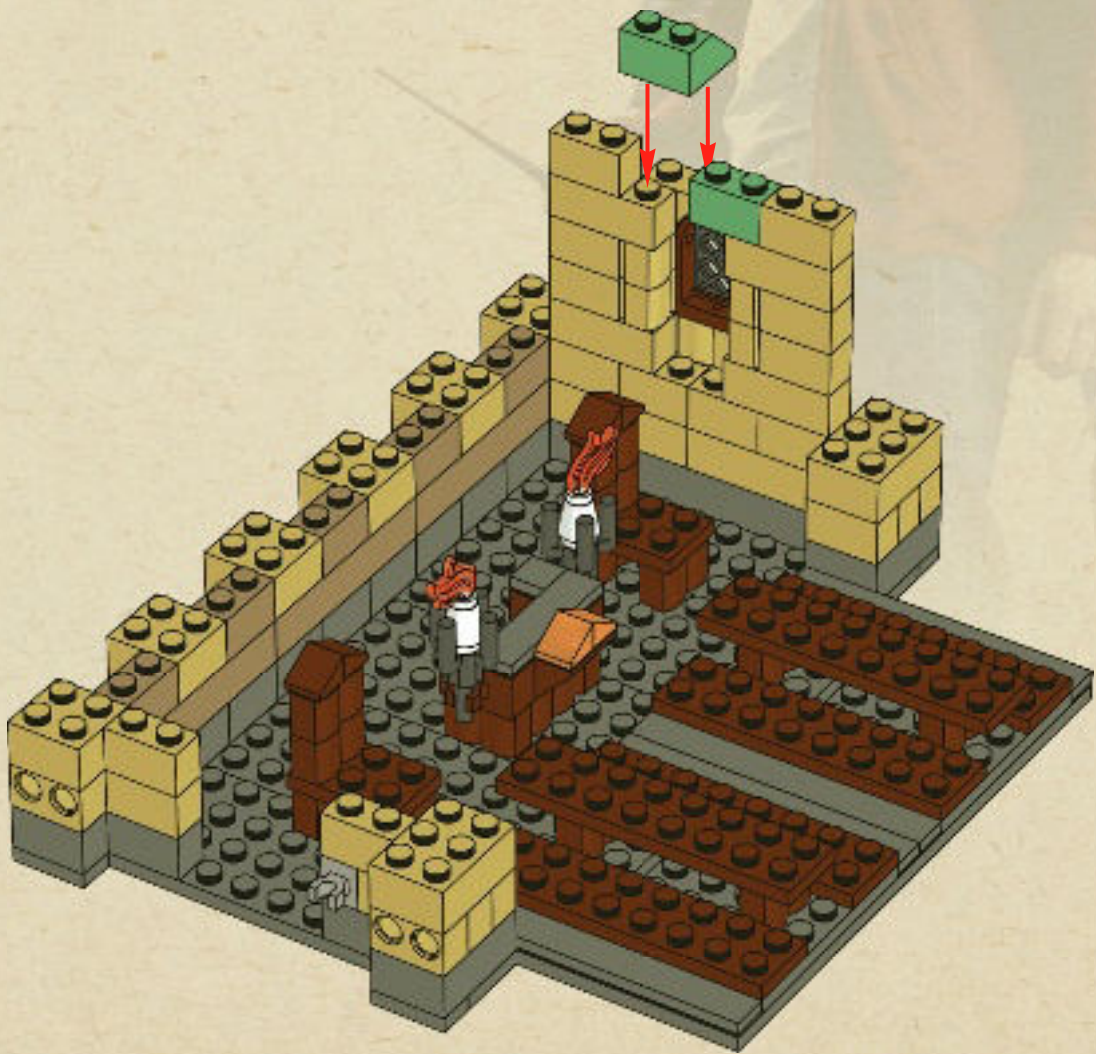

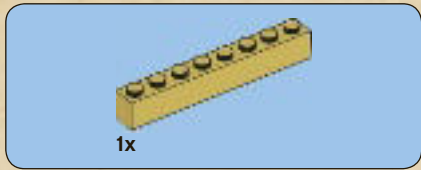

# 32

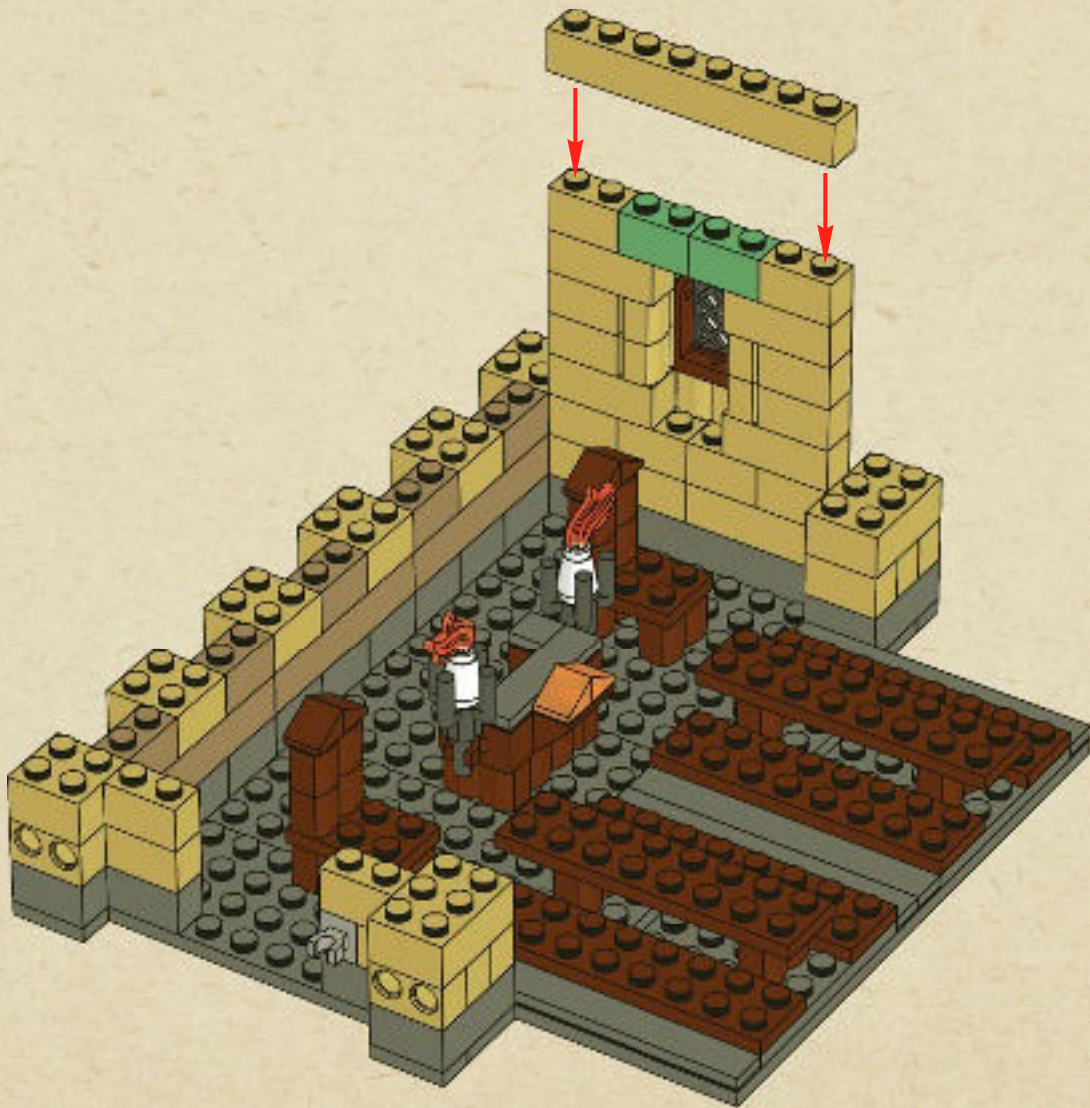



24x

# 33

1



2



4x

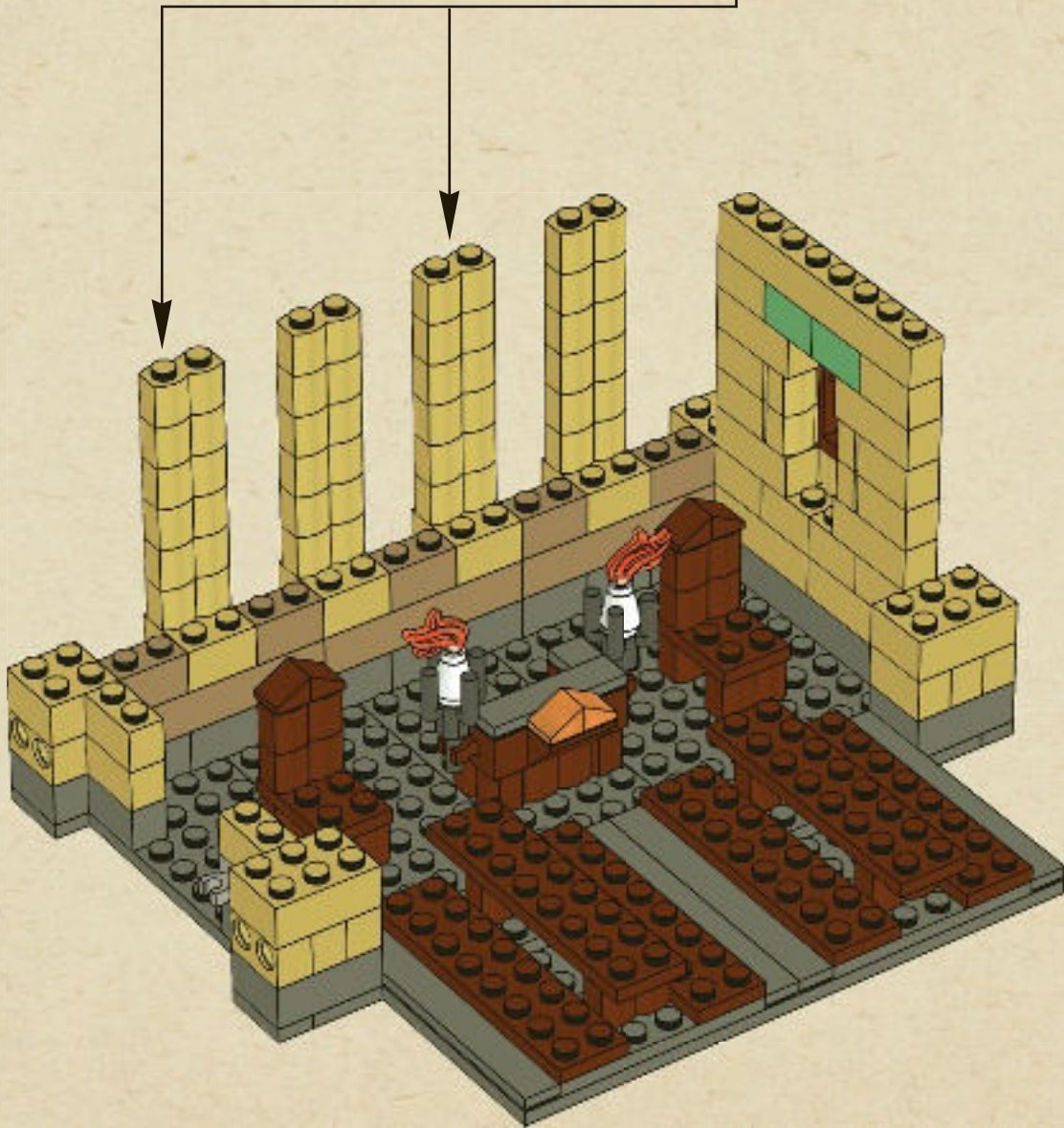

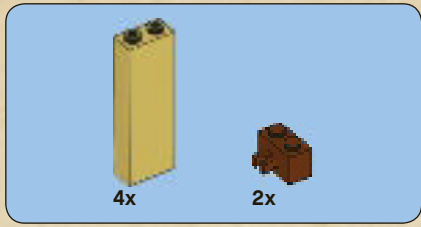

34

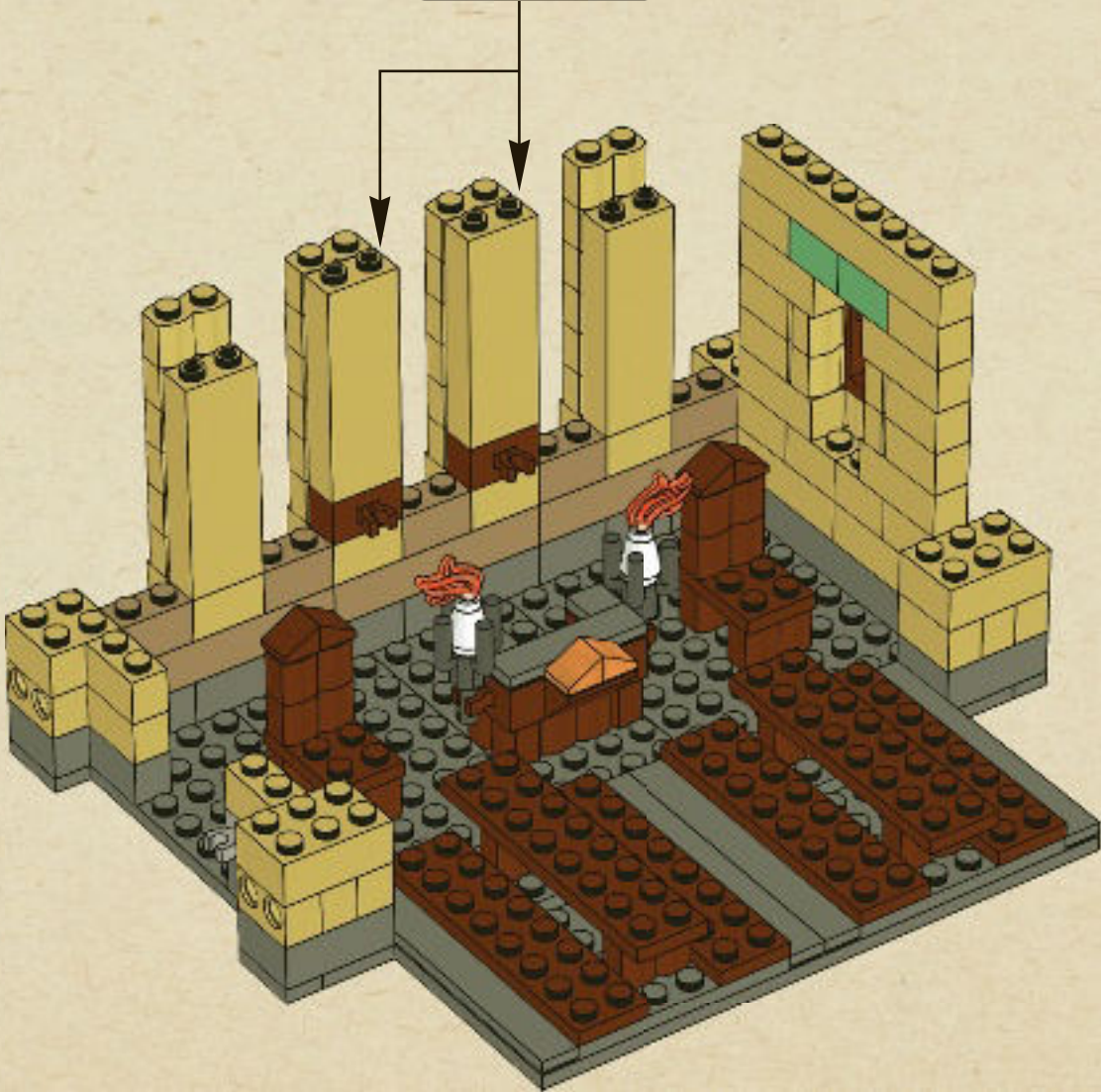
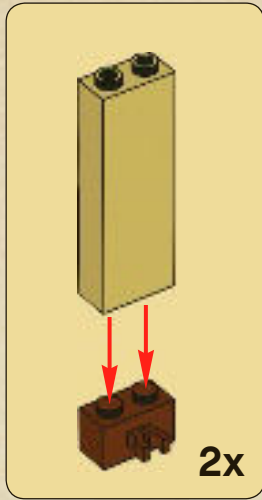



# 35

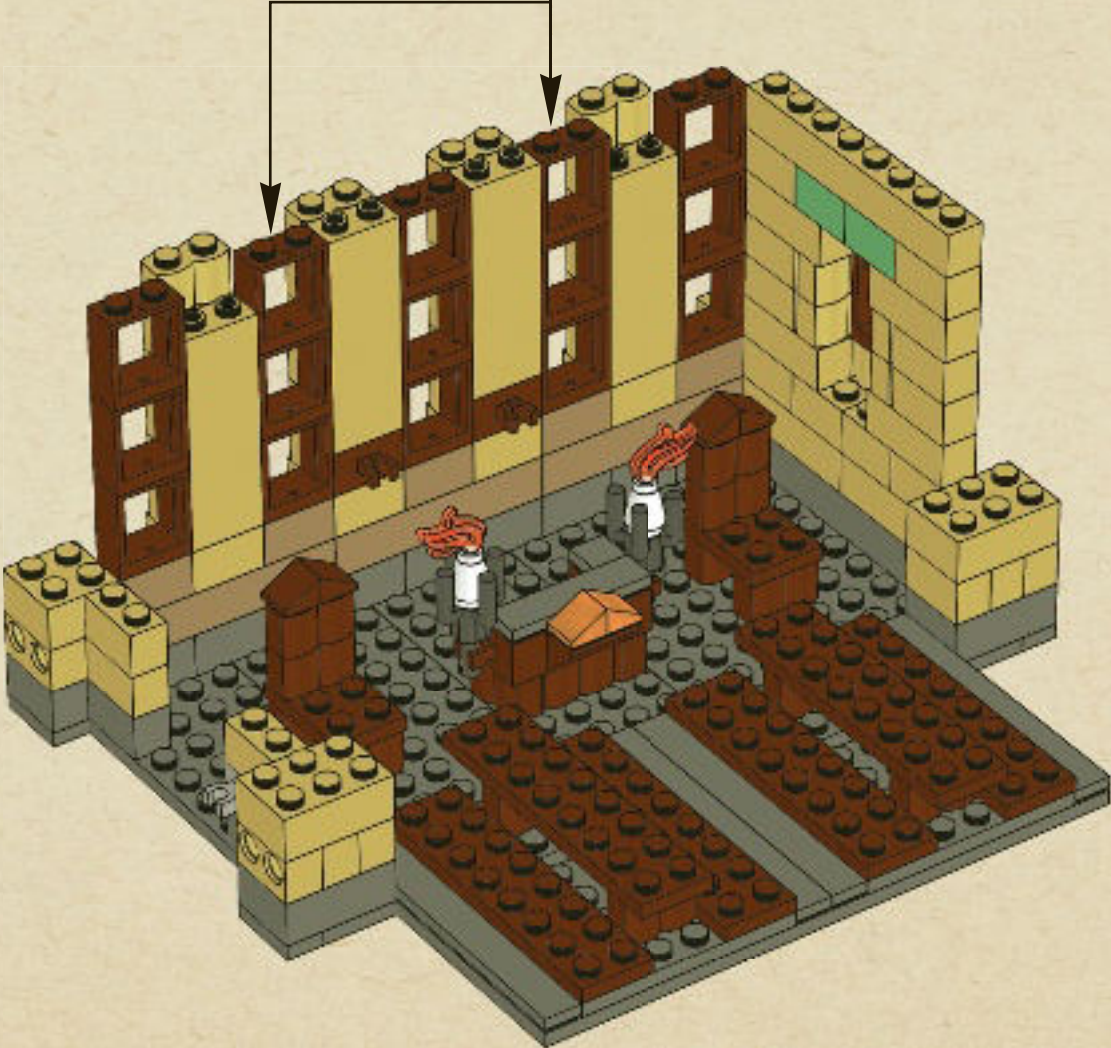
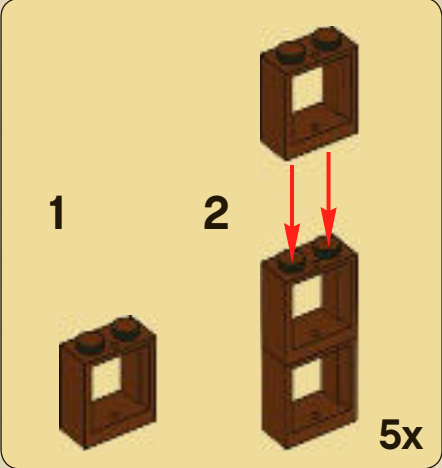



# 36

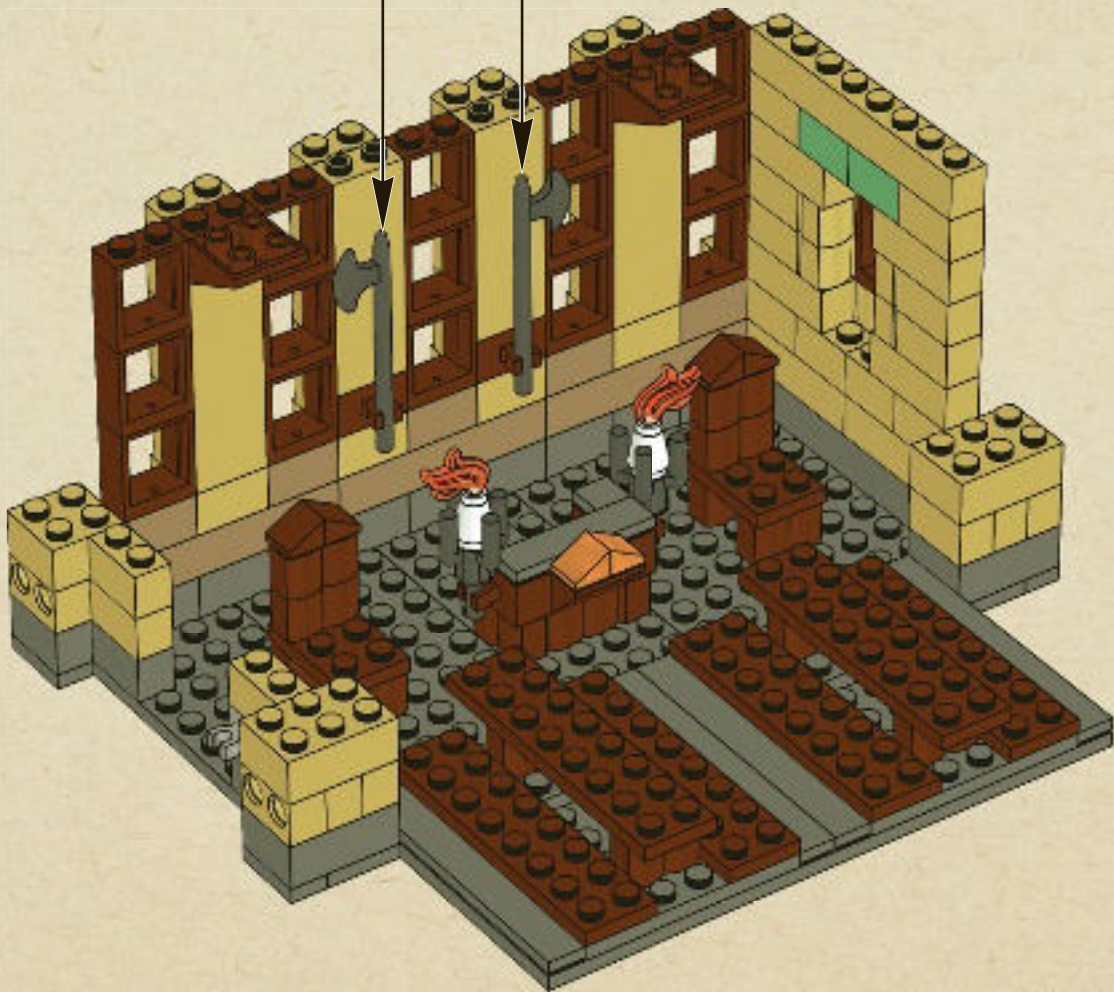
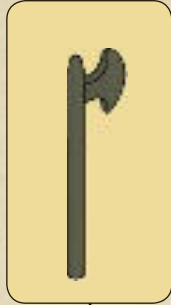



1x



1x



1x

# 37

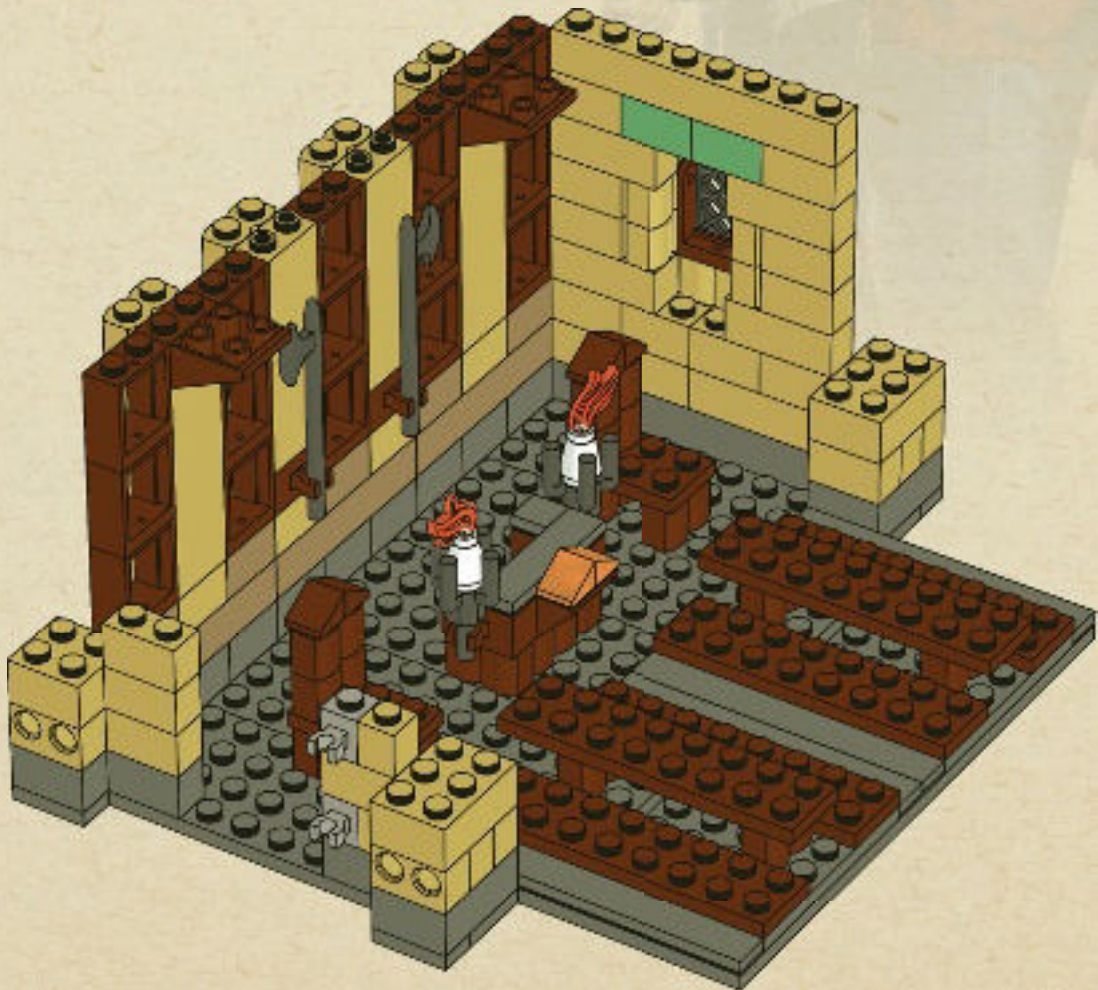

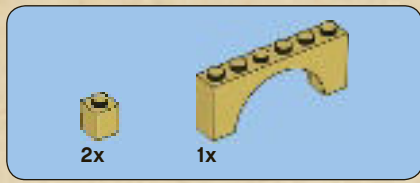

# 38

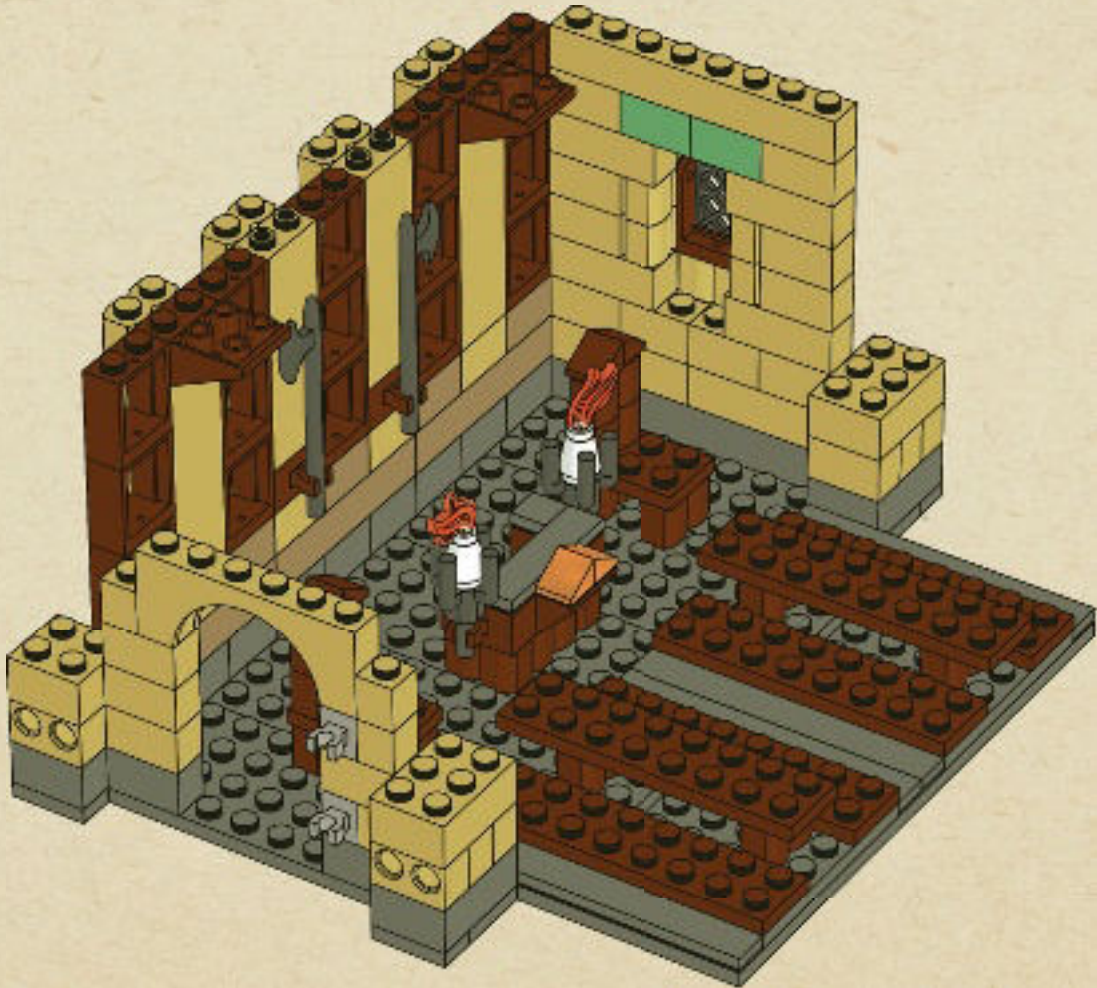



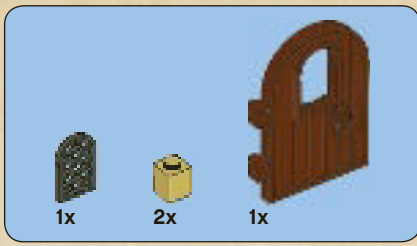

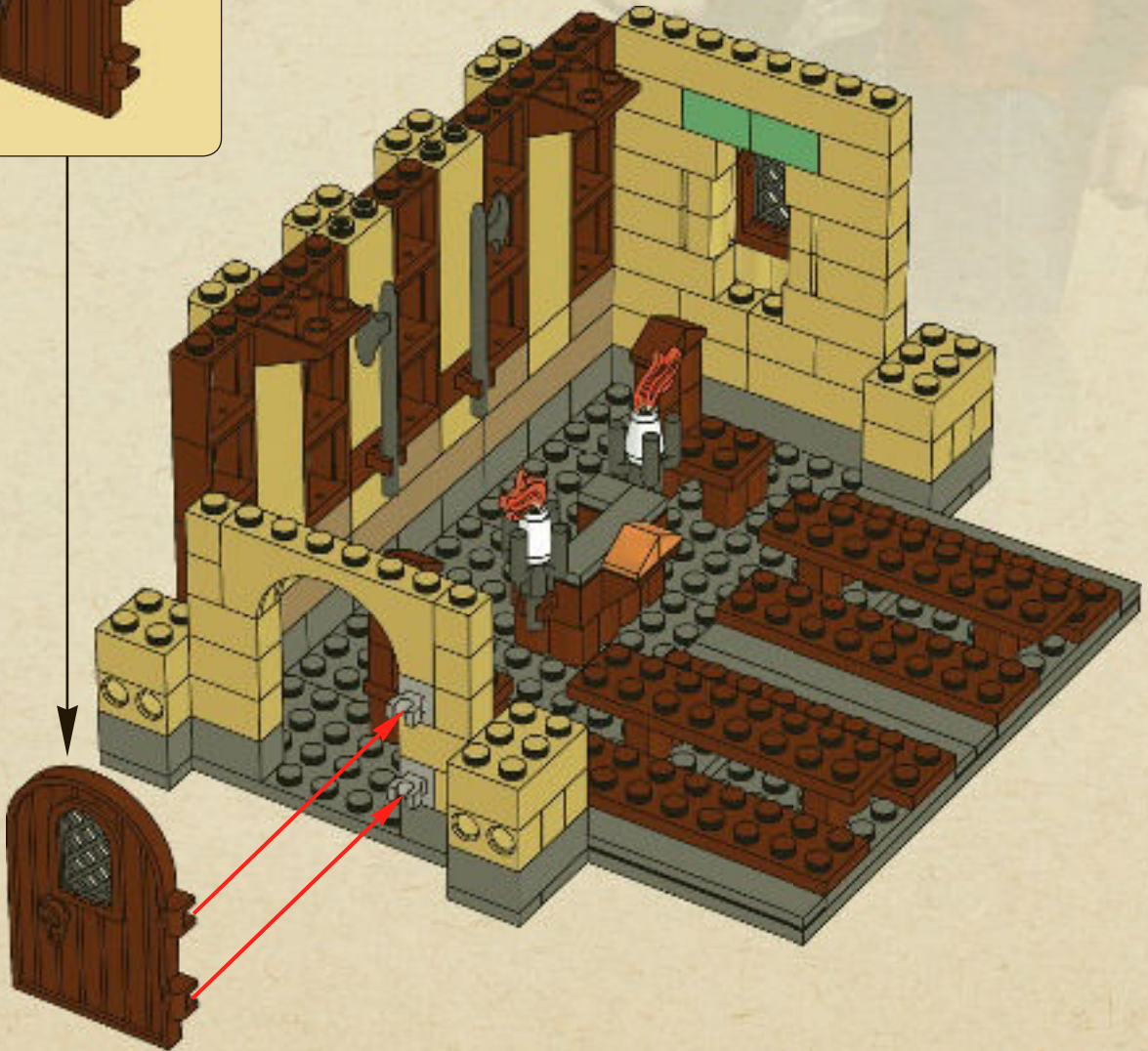

39



1x  2x 

# 40

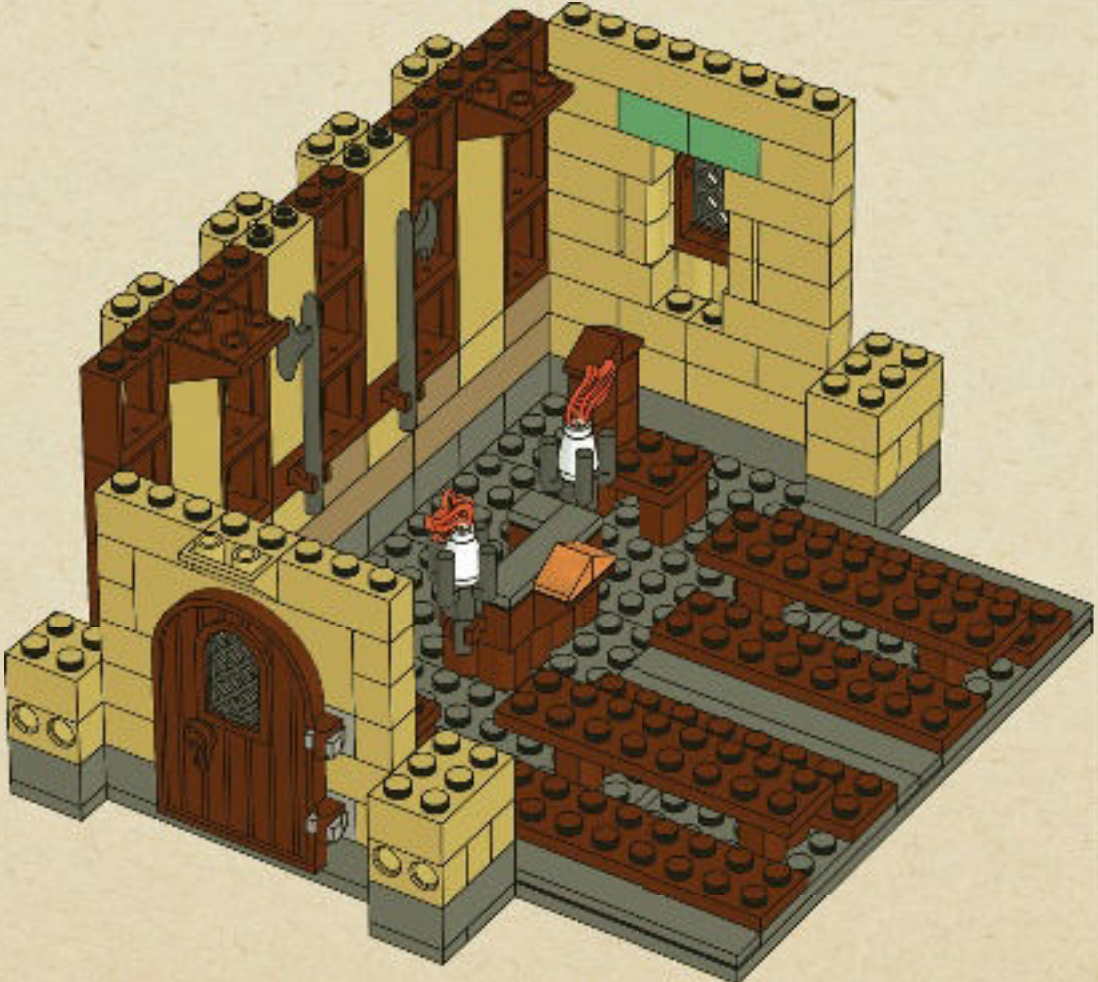

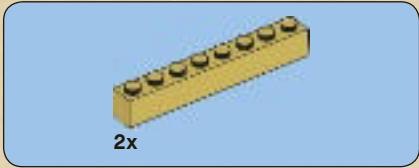

# 41

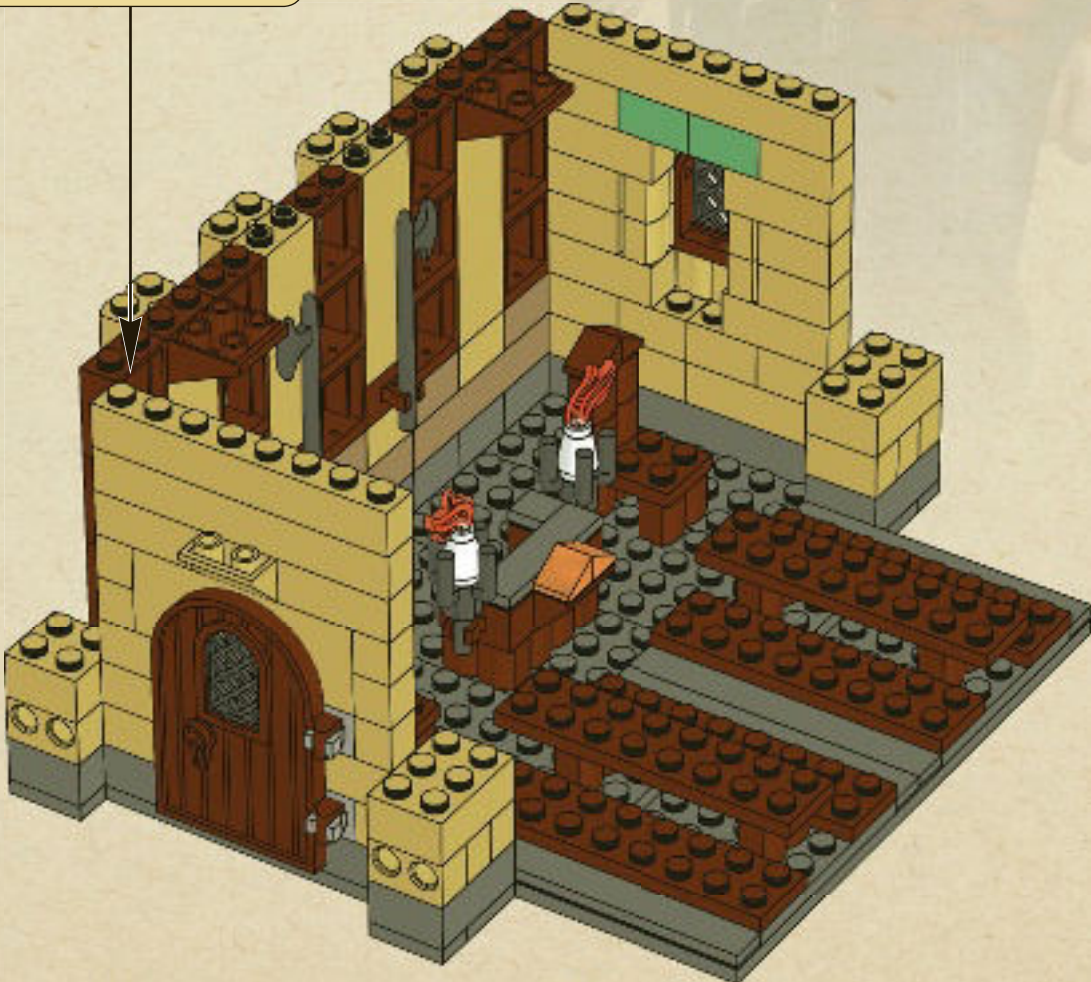
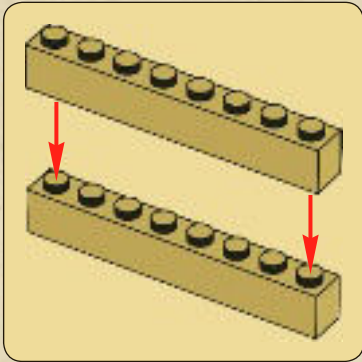



# 42

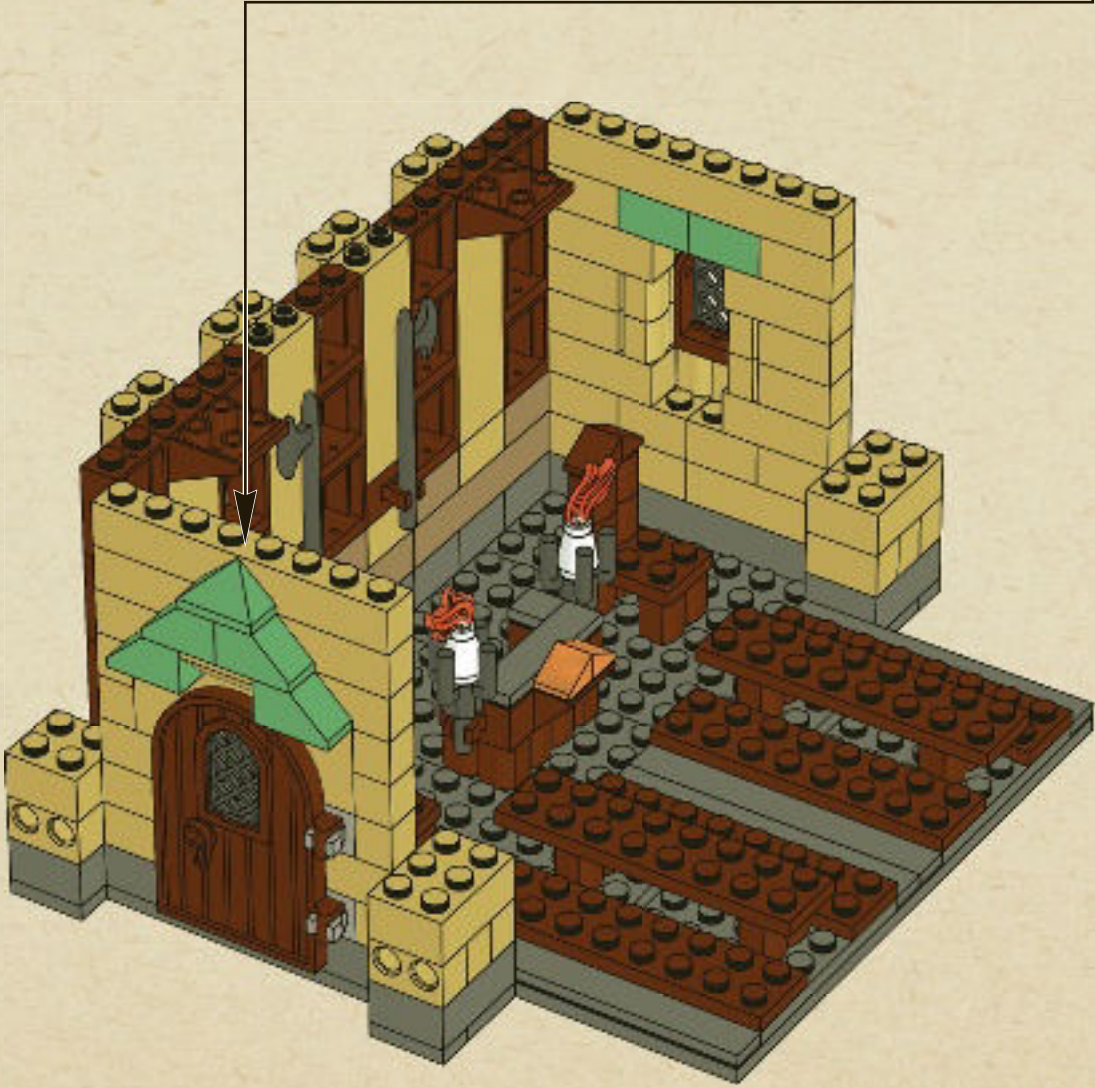
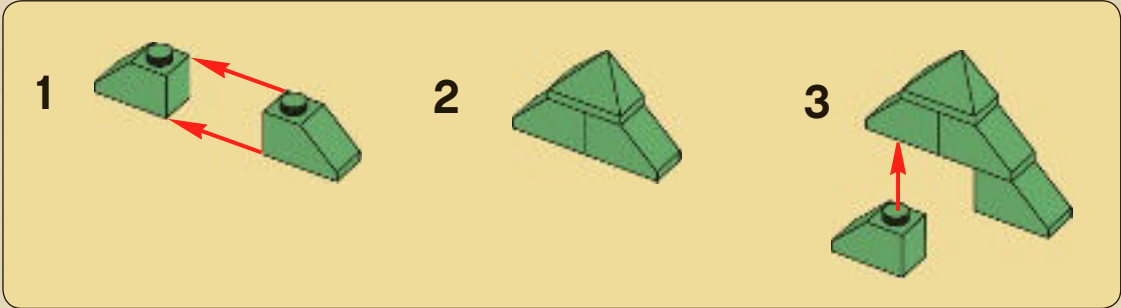

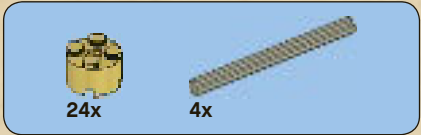

# 43

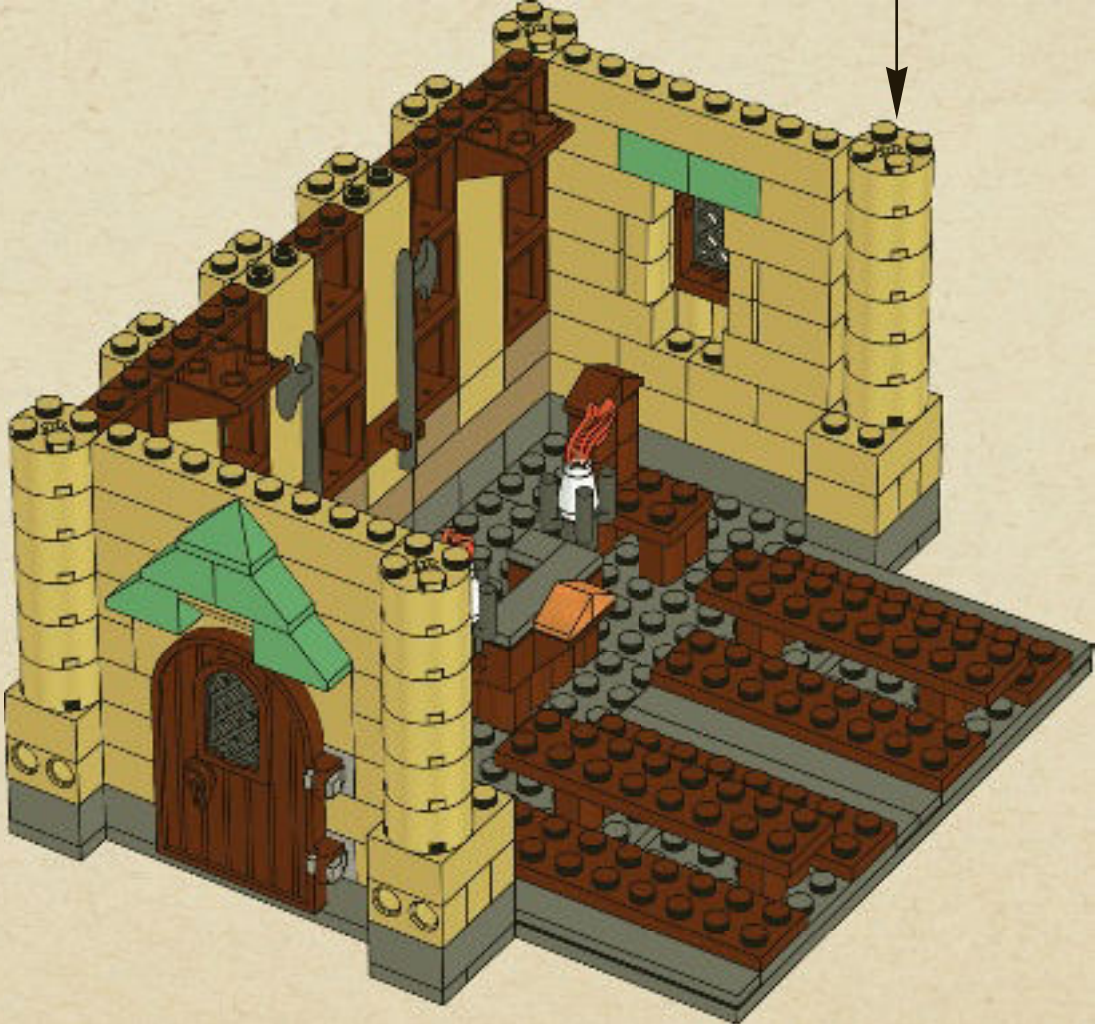
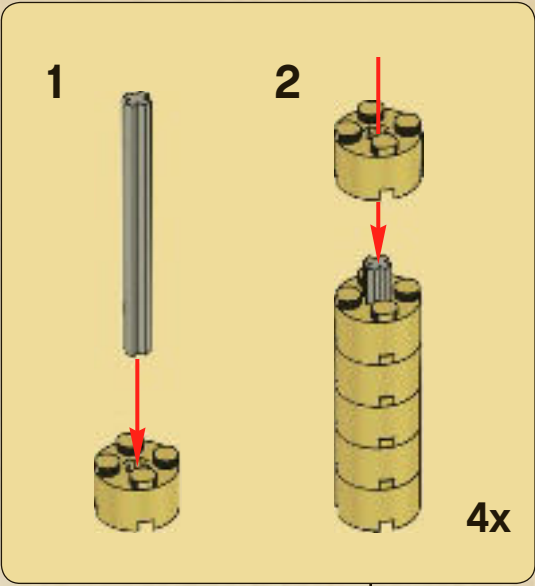



44

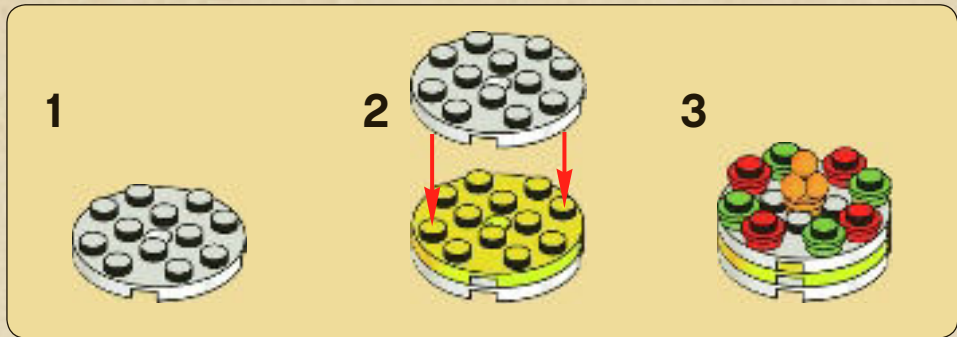



# 45

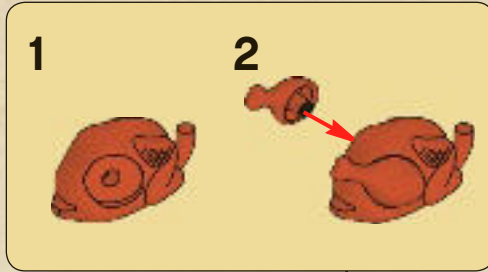



8



2x



5x

46





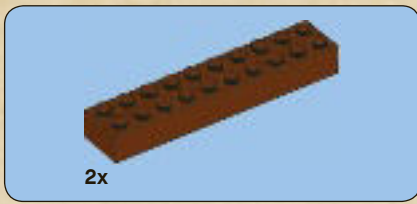

47





5x



5x

# 48

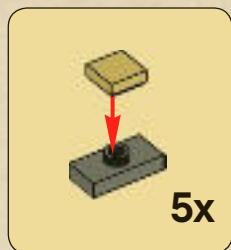

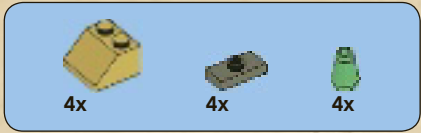

# 49

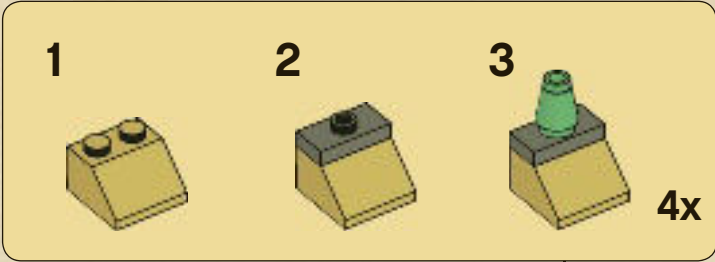



2x



2x

# 50

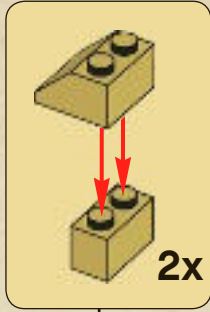



51





# 52





# 53

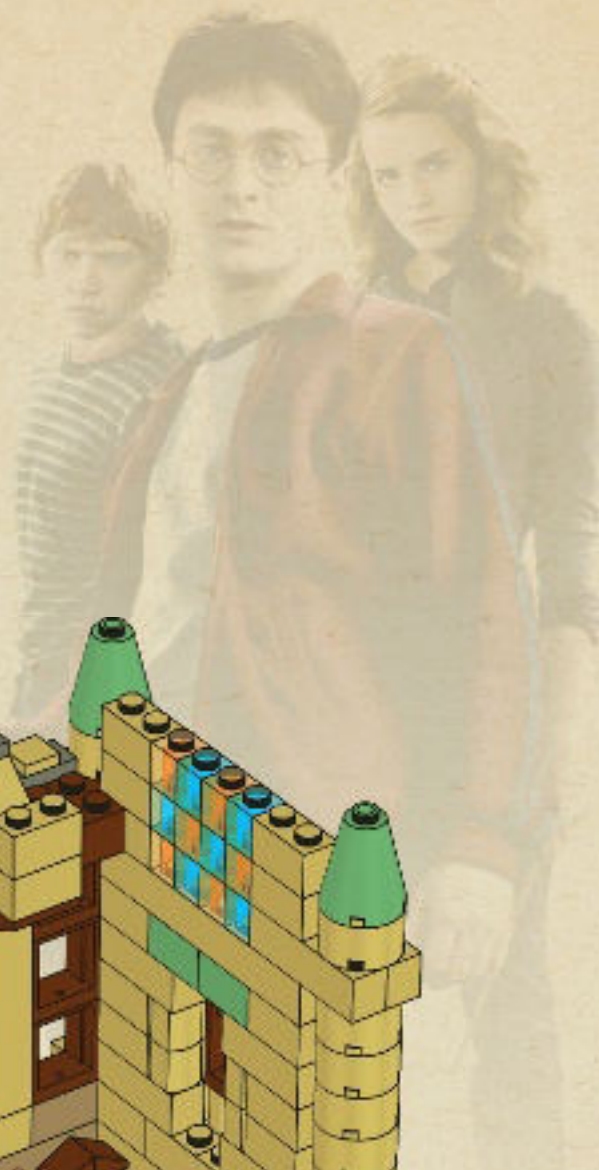



4x



2x



2x

# 54







2x

55





2x

# 56

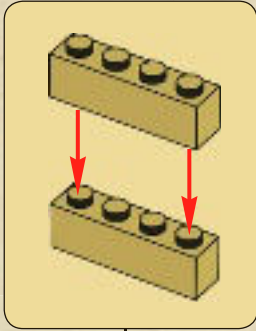

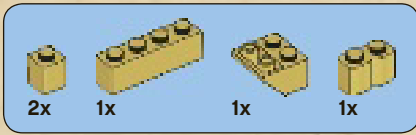

# 57

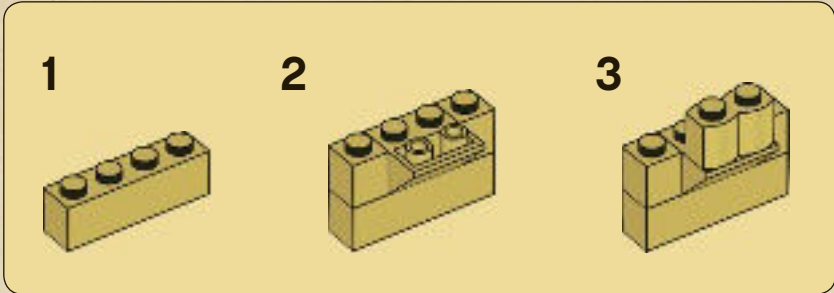

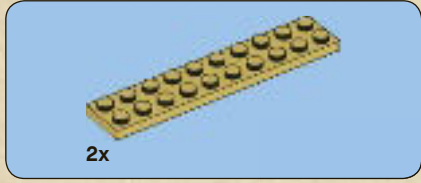

1

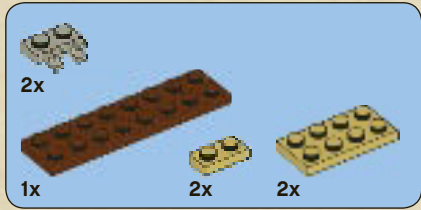
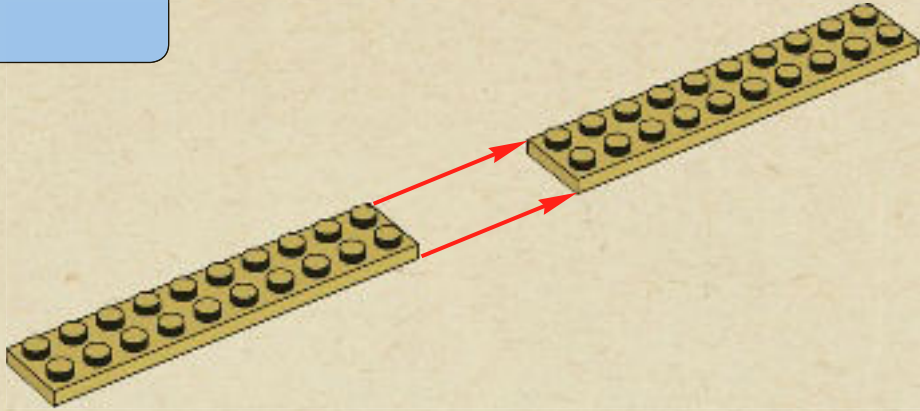

2

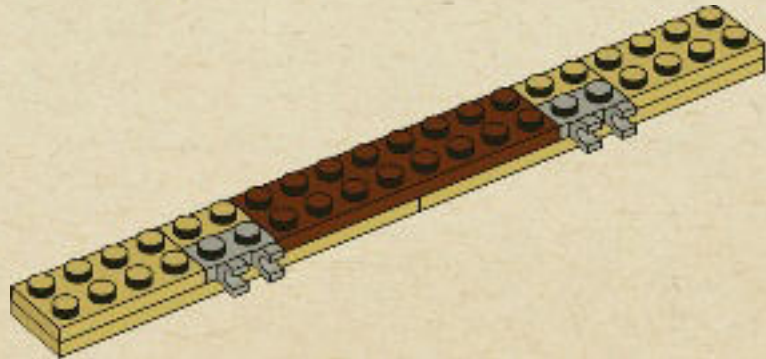

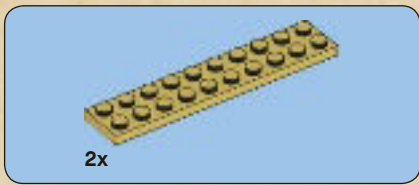

3

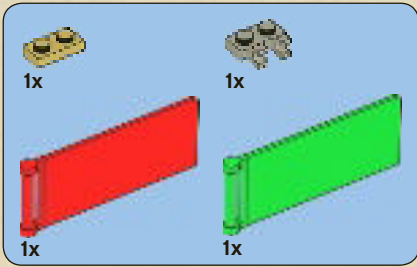
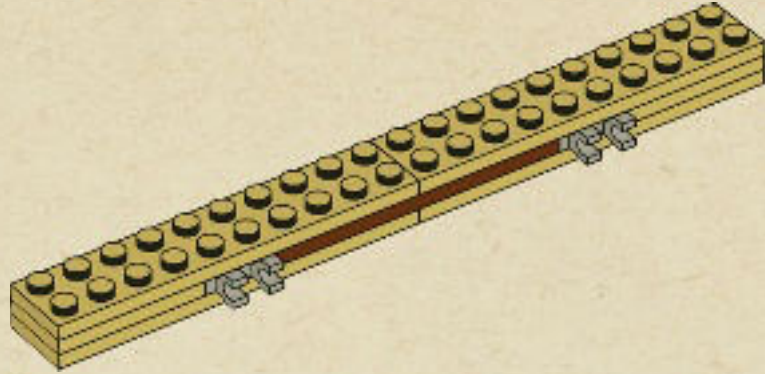

4

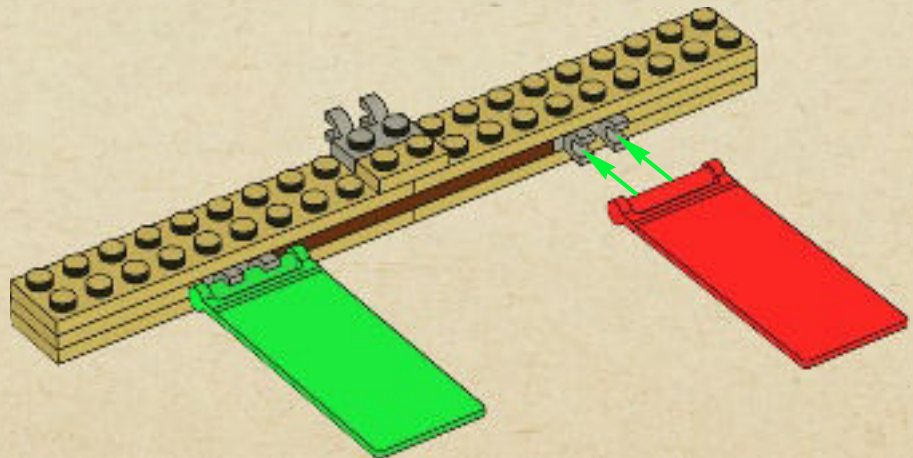

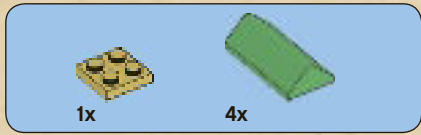

5

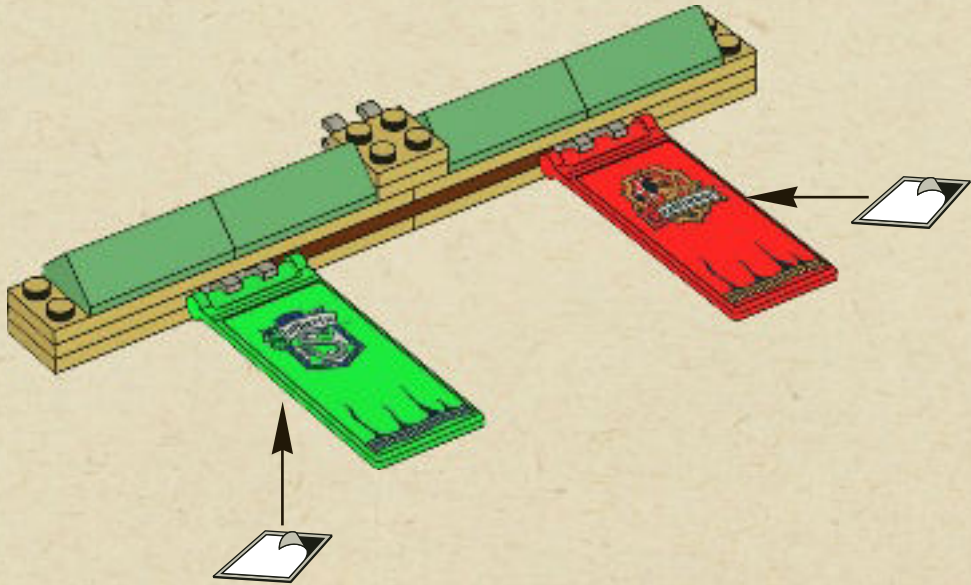

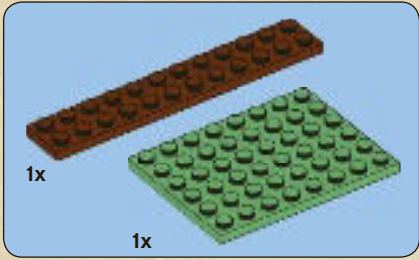

1

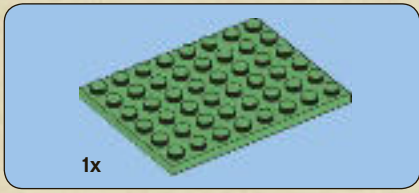
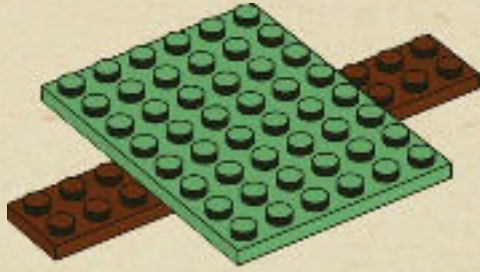

2

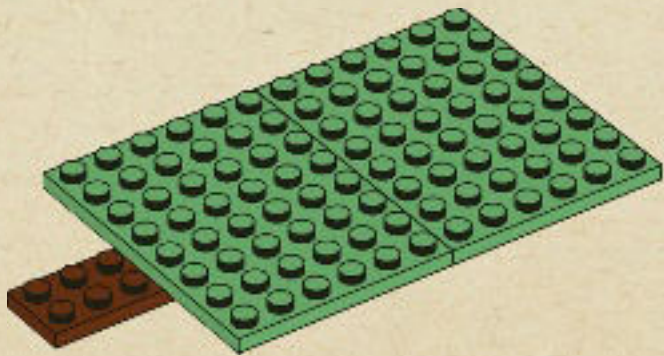

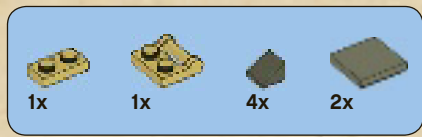

3

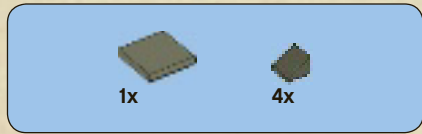
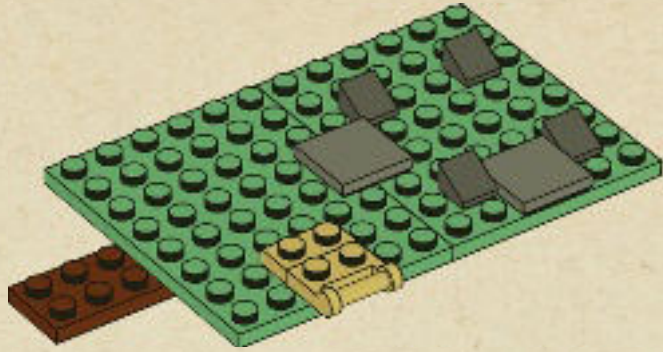

4

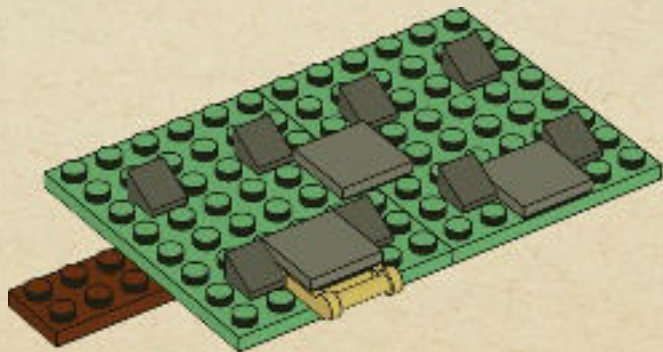



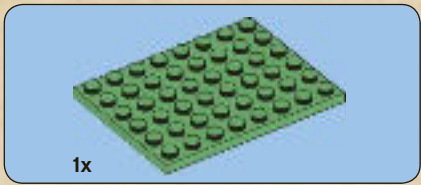

5

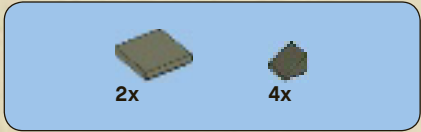
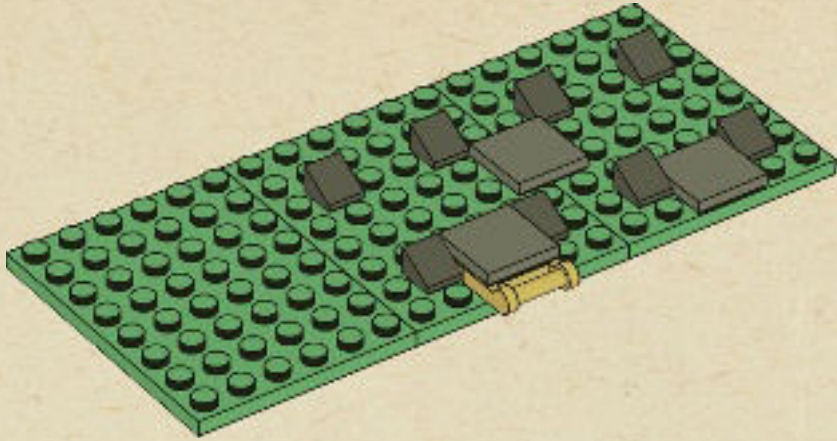

6

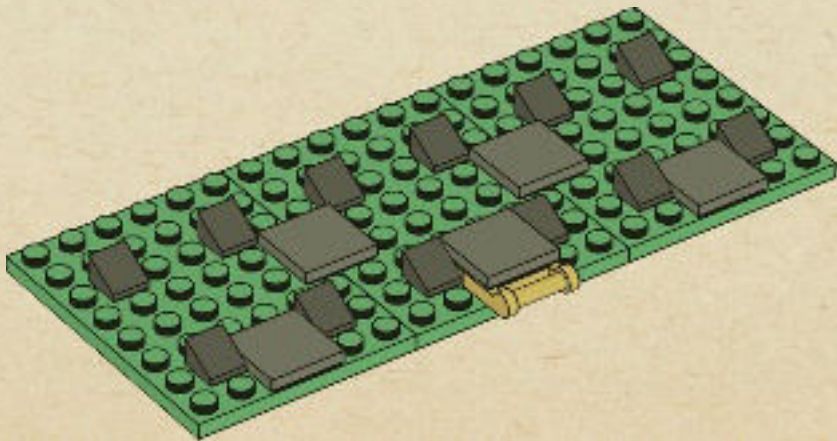

7

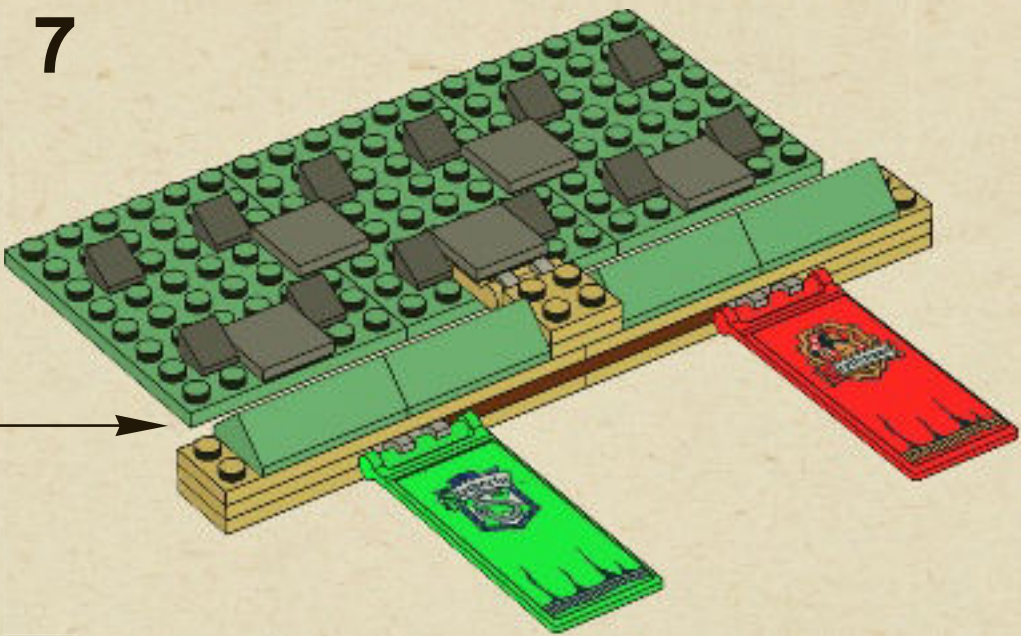

8

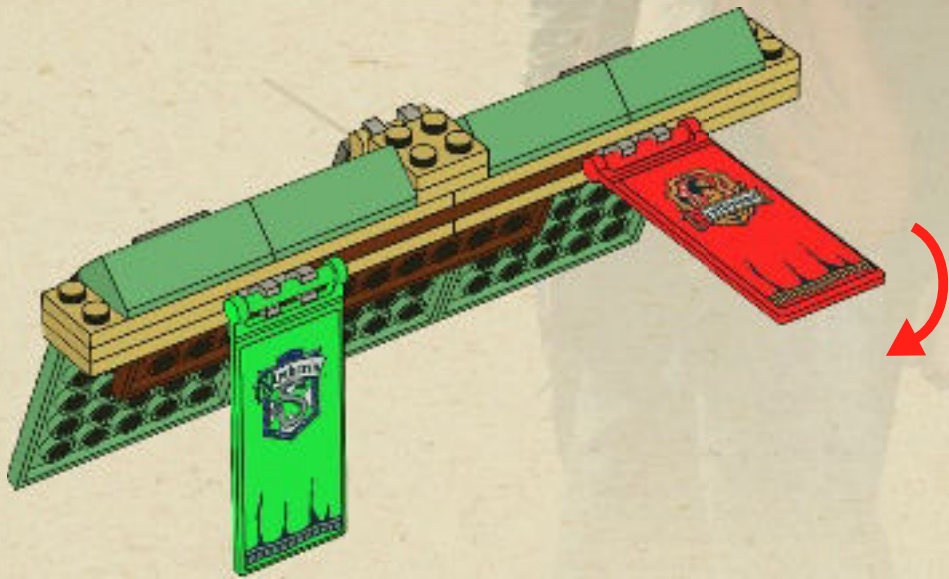

58





# 59

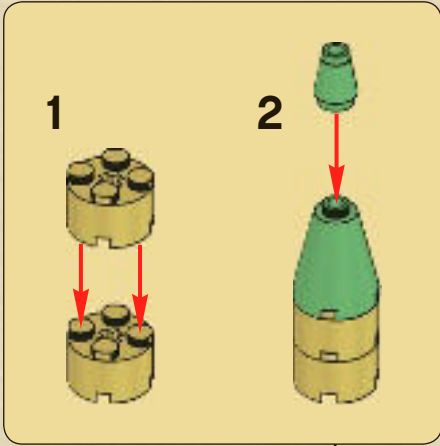

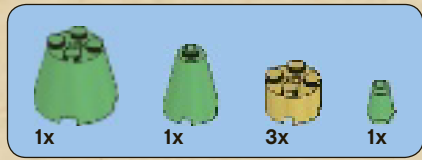

60

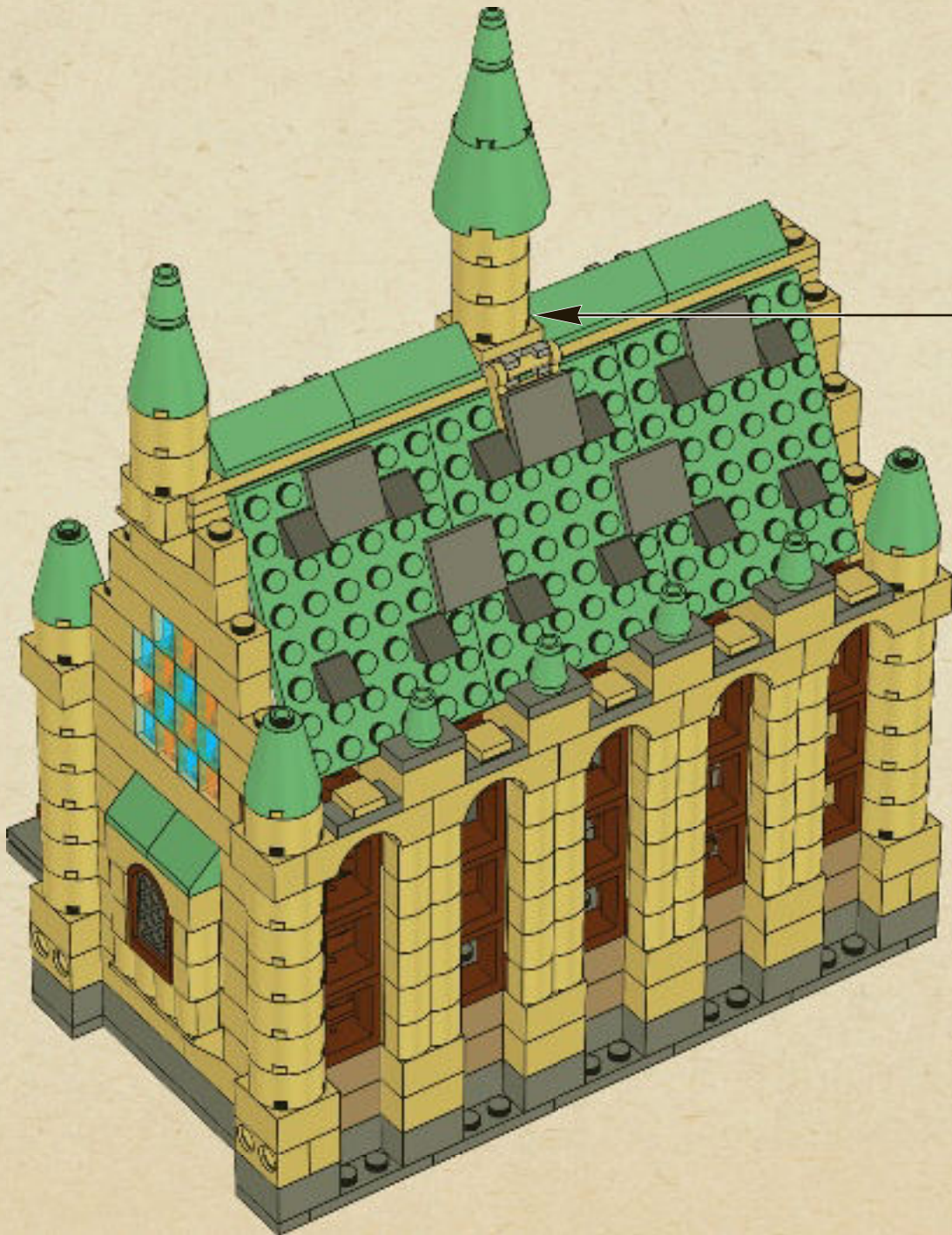
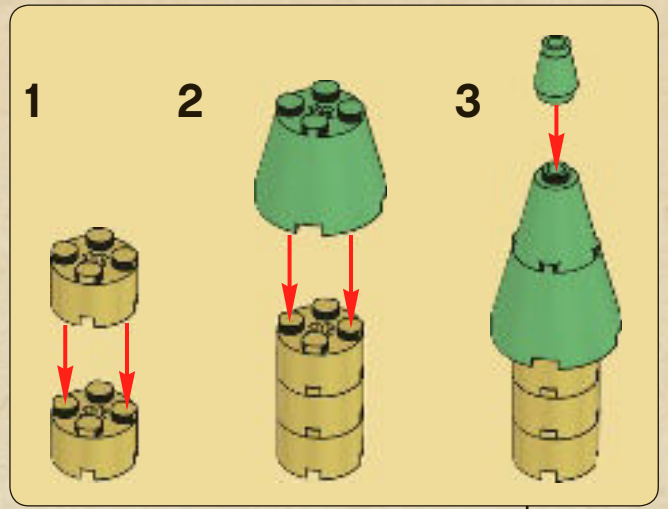



61

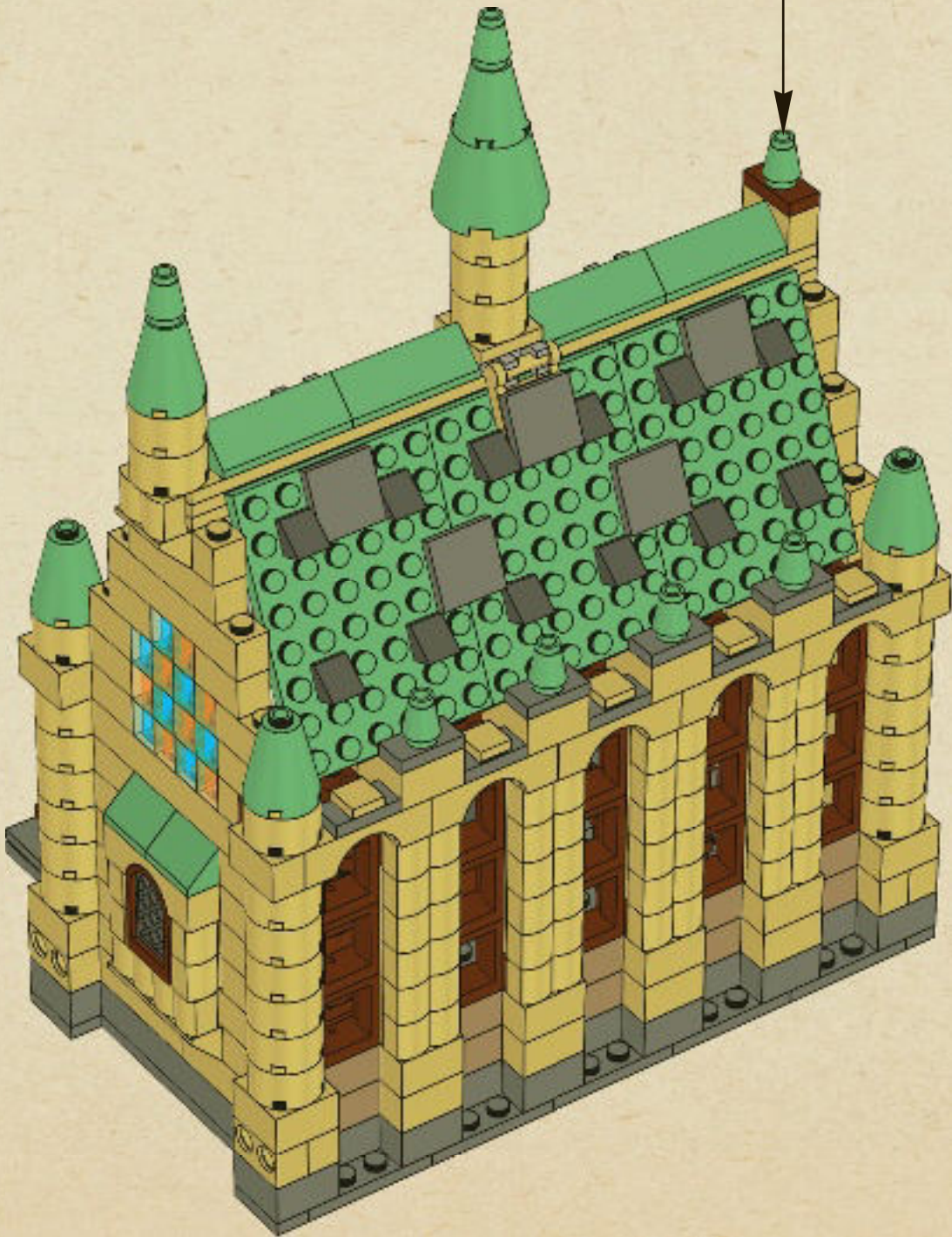
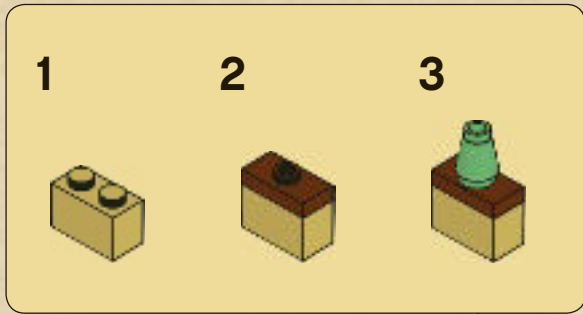



1x

1



1x

2



1x

3



1x



4x

4

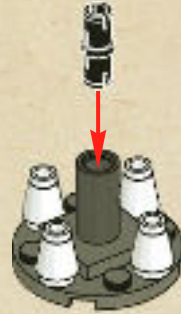

4x



1x

5



1x

6

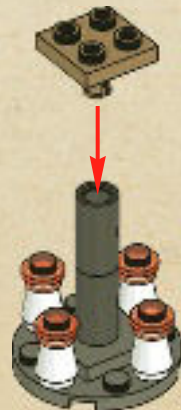



62



63

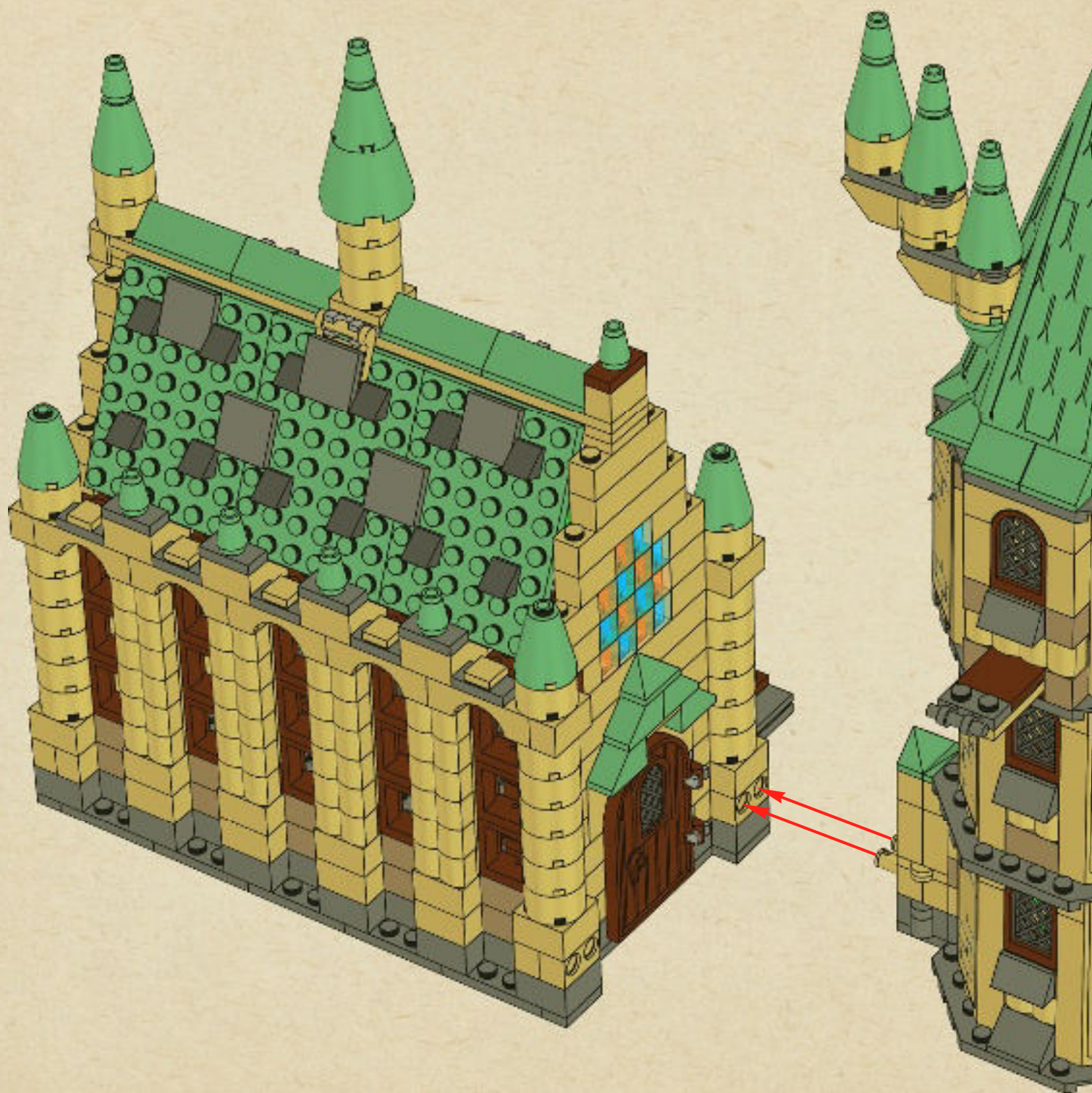



64



# Harry Potter HOGWARTS™



3862  
Harry Potter™ Hogwarts™

    
2-4 8+ 20-40





# Harry Potter





# ATLANTIS



8078



8077



8076

**FREE! GRATIS! GRATUIT!**



**club**  
MAGAZINE™

**www.LEGOclub.com**



**00800 5346 5555\***



**1-866-534-6258 • 1-877-518-5346**

US & Canada only

Canada seulement

\* FreePhone. Mobile charges may apply. \* Numéro sans Frais. Des Frais peuvent s'appliquer avec les téléphones cellulaires. \* Gebührenfrei, Kosten für Anrufe aus Mobilfunknetzen können abweichen. \* gratis telefoonnummer vanaf vaste lijn. \* Det er ett gratis nummer, når du ringer fra Fasttelefon. \* Det er gratis, når du ringer från en Fast telefon.



**VISIT THE WORLD'S  
BIGGEST LEGO® SHOP!**

**www.LEGOshop.com**



**www.LEGO.com**





# Harry Potter



4842



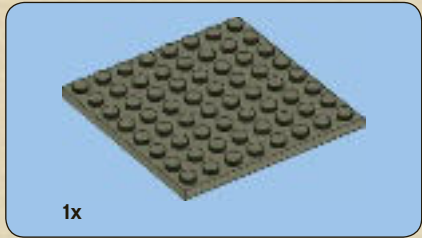
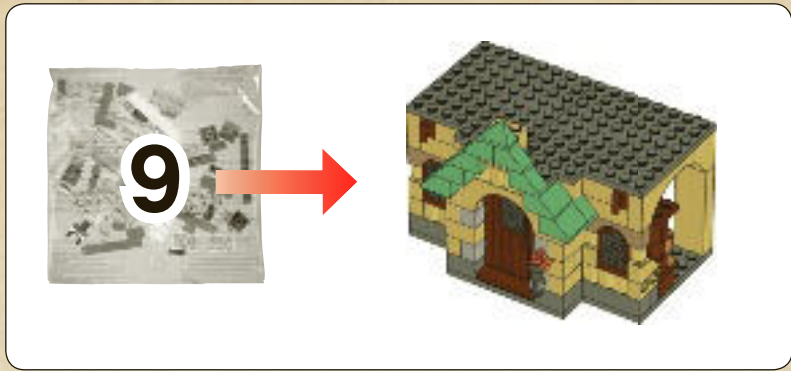

1

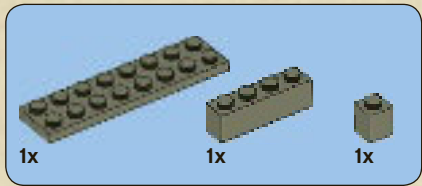
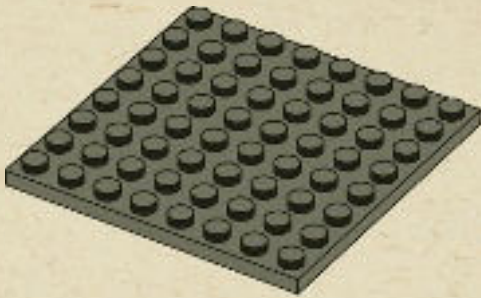

2

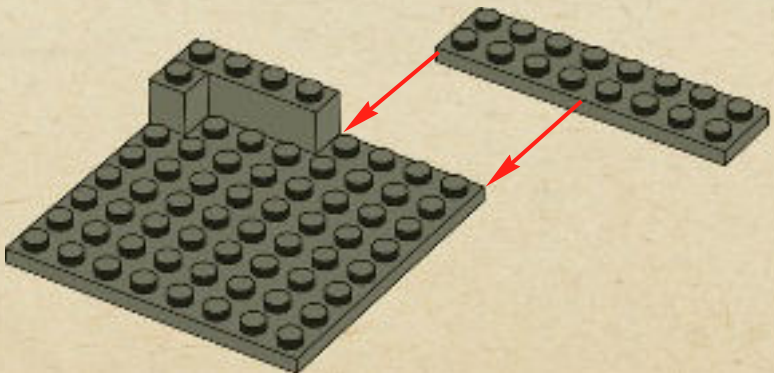

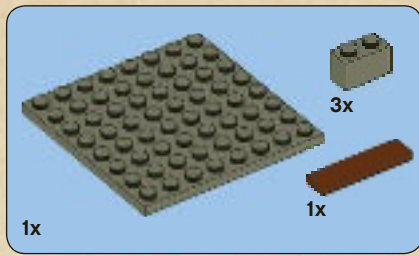

3

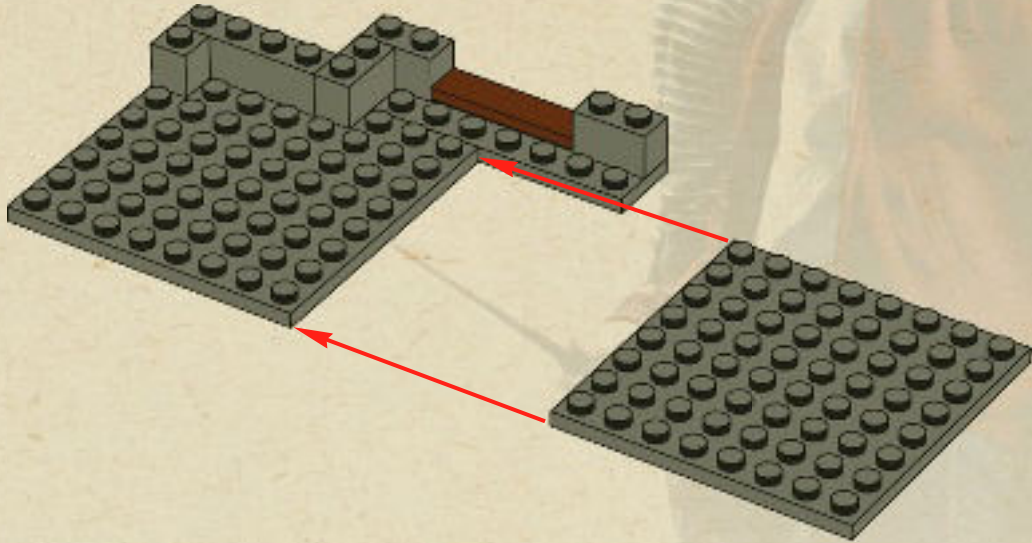

4

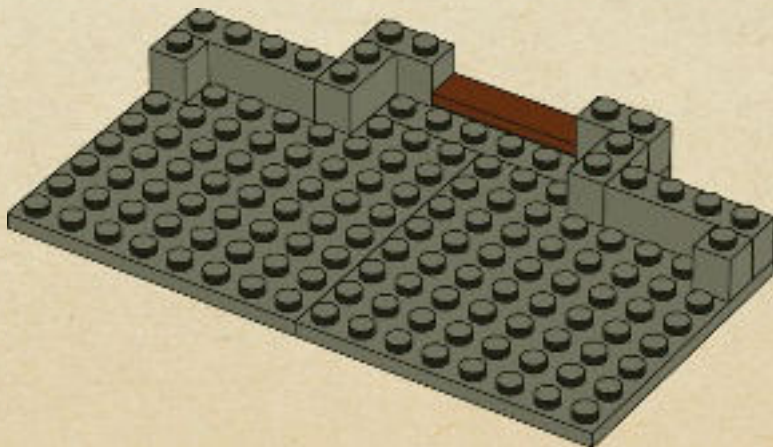



2x

# 5

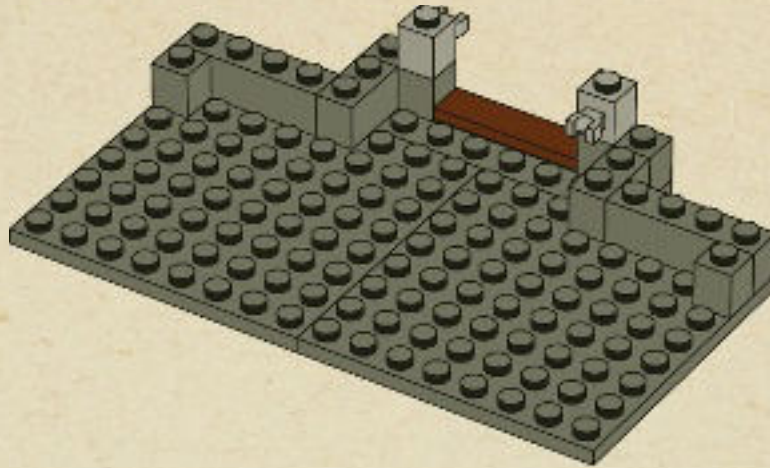

2x



2x



2x

# 6

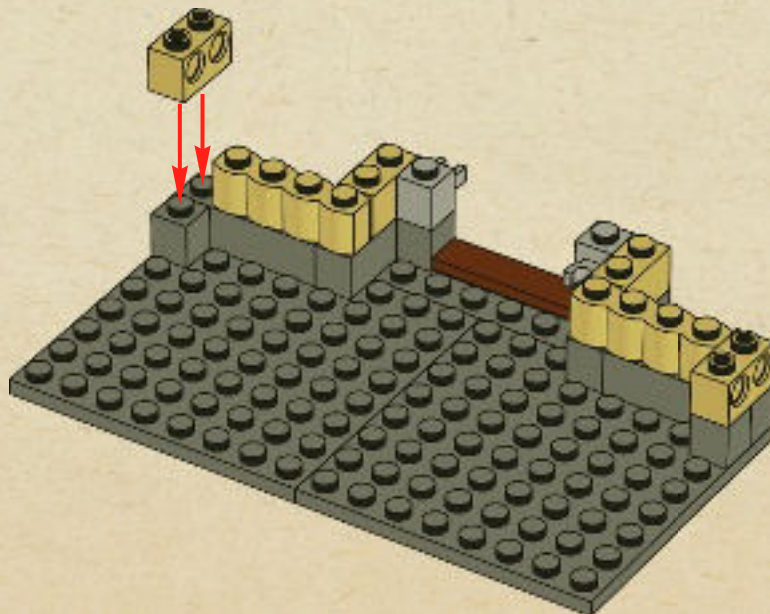

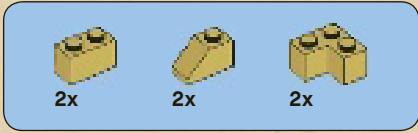

7

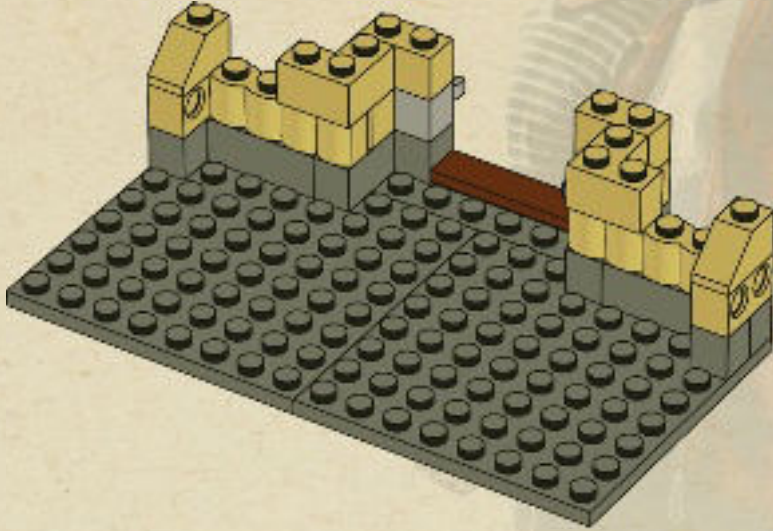

8

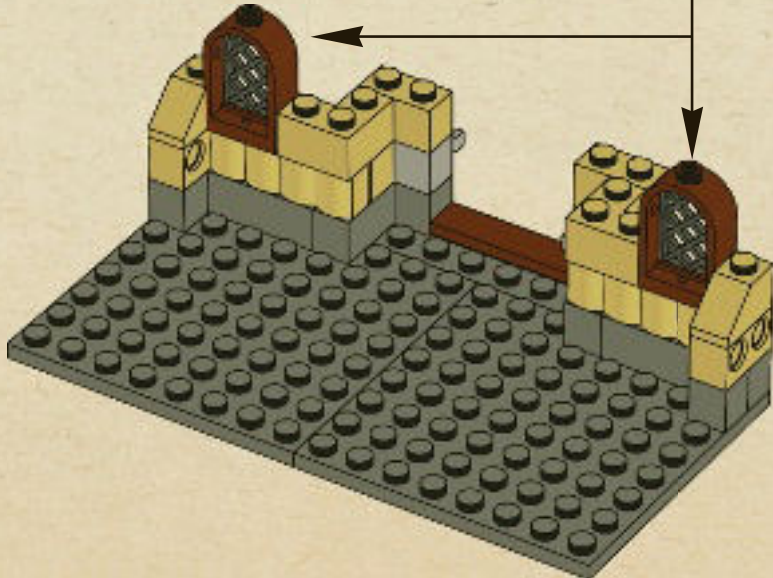



2x

# 9

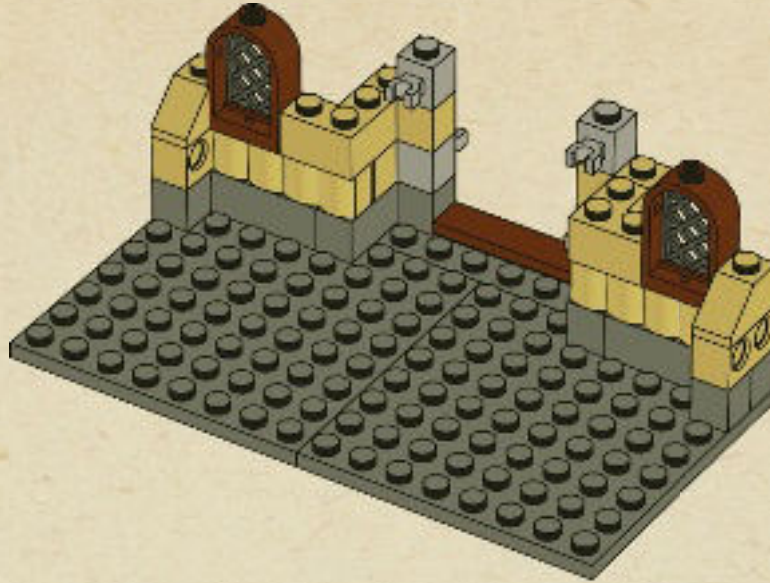

4x



2x

# 10

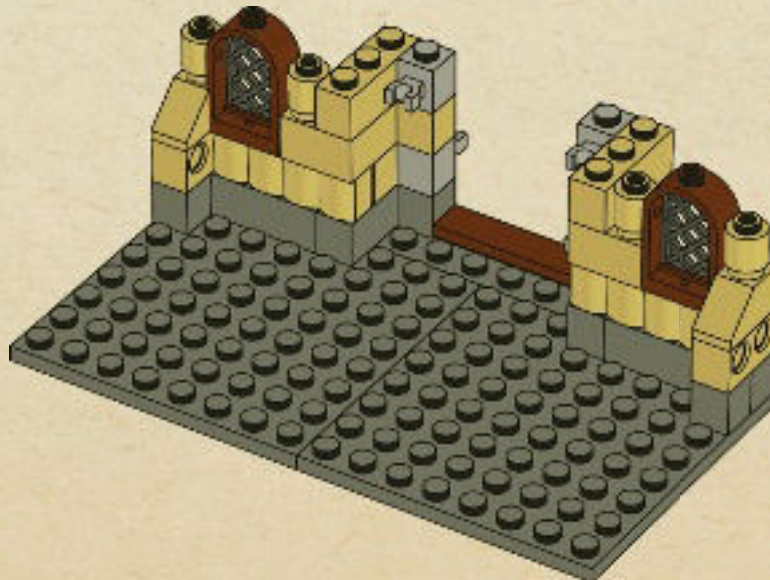

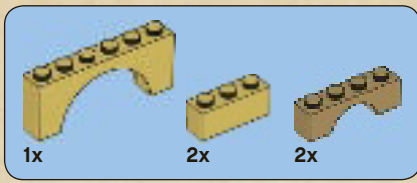

11

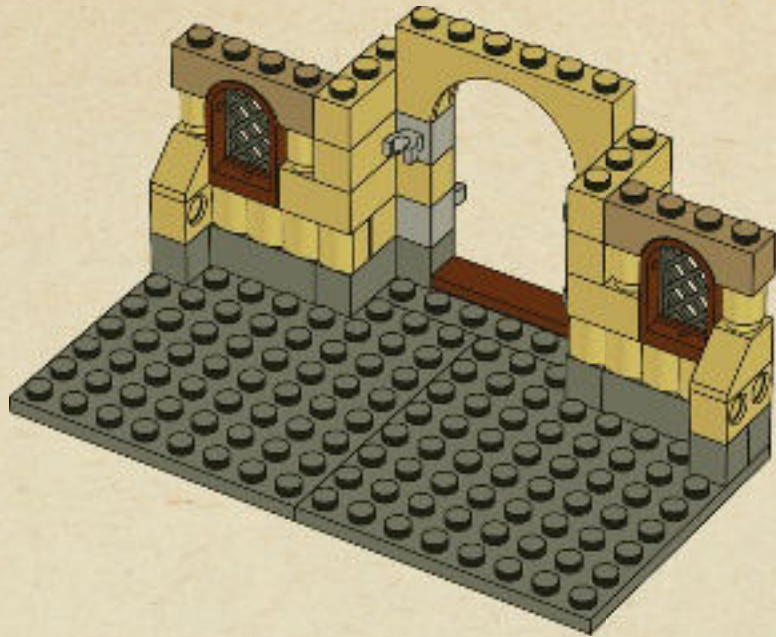

12





13

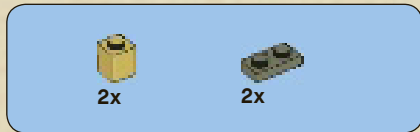

14

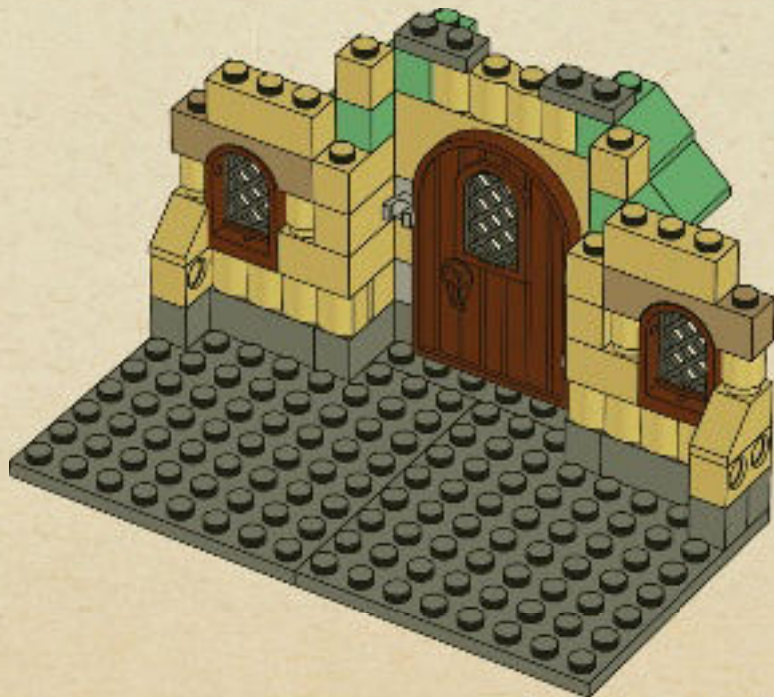



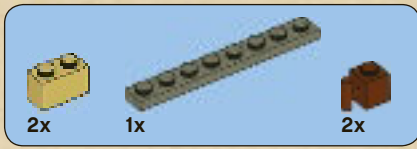

15

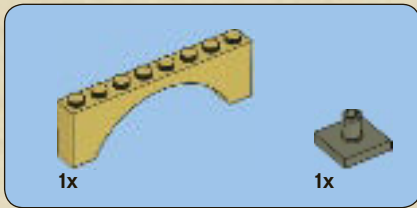
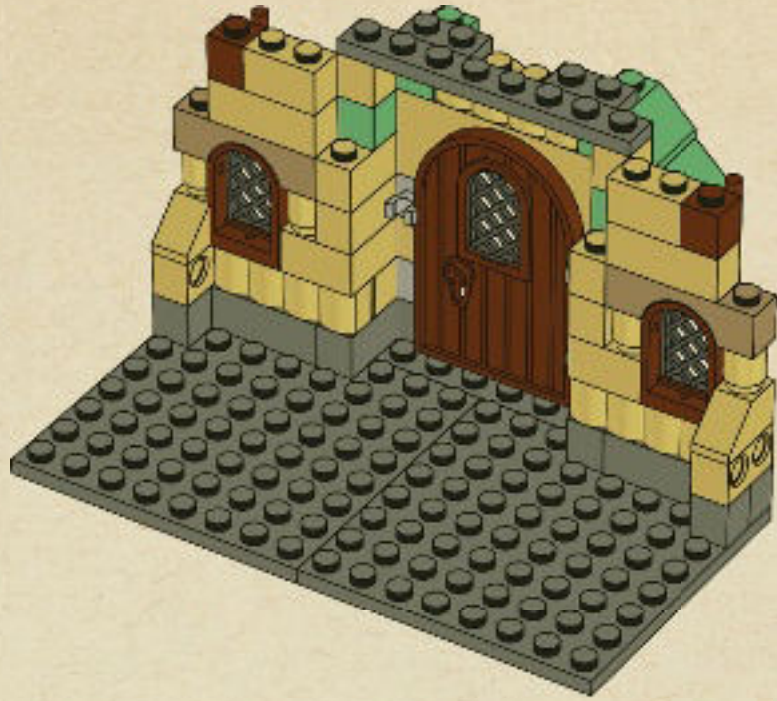

16





1x

1



2x

2

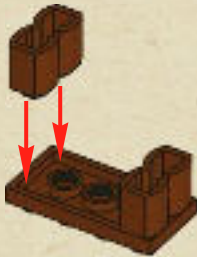

1x

3



2x



2x

4



1x



1x

5

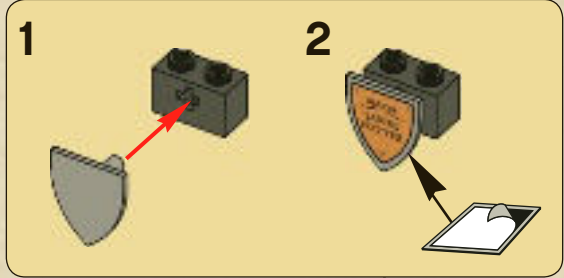

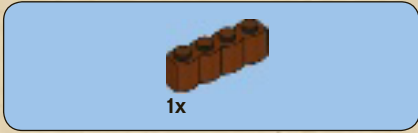

6



7



17

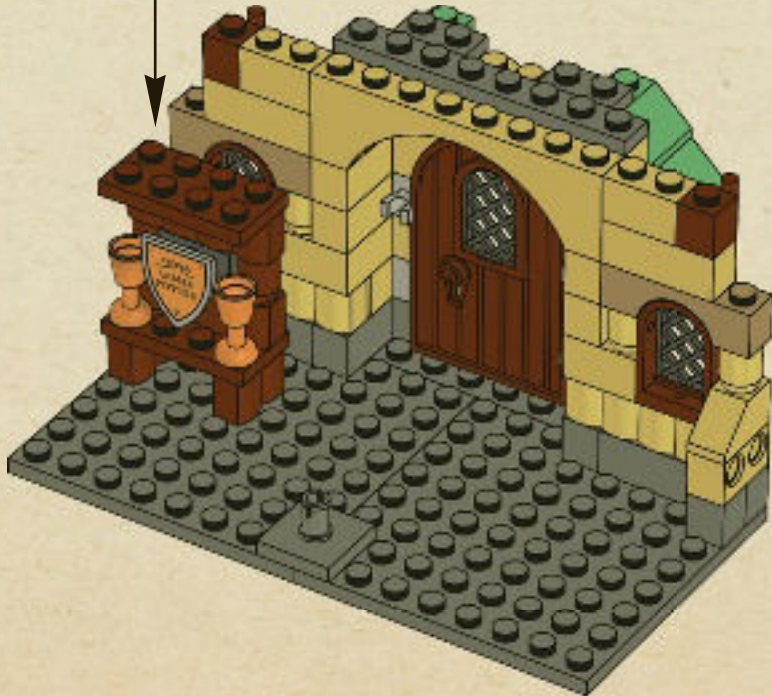

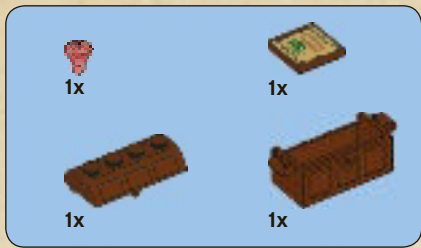

# 18



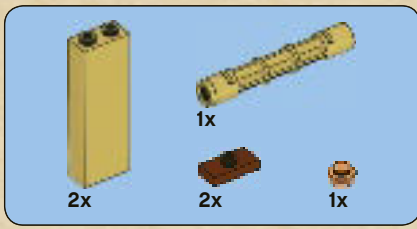

19

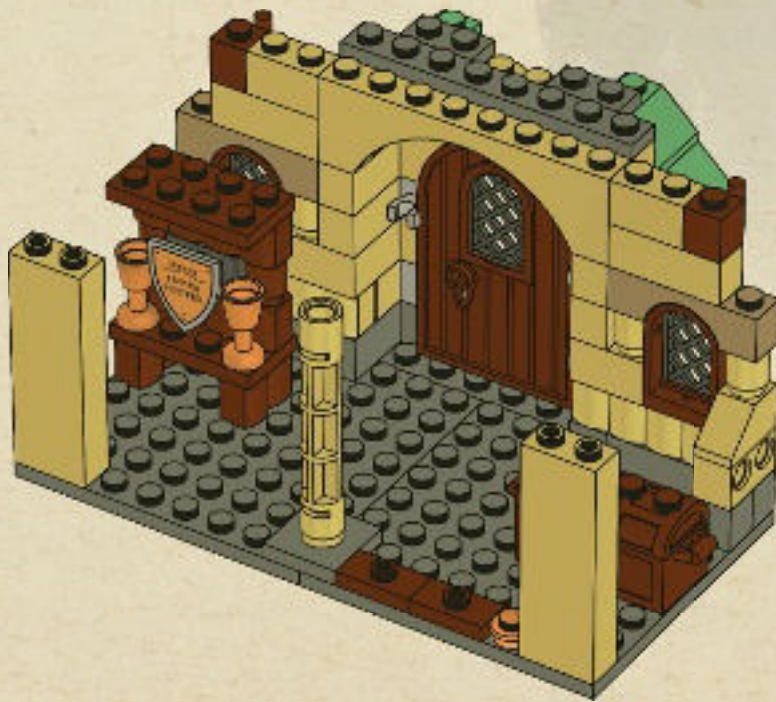



1x

20

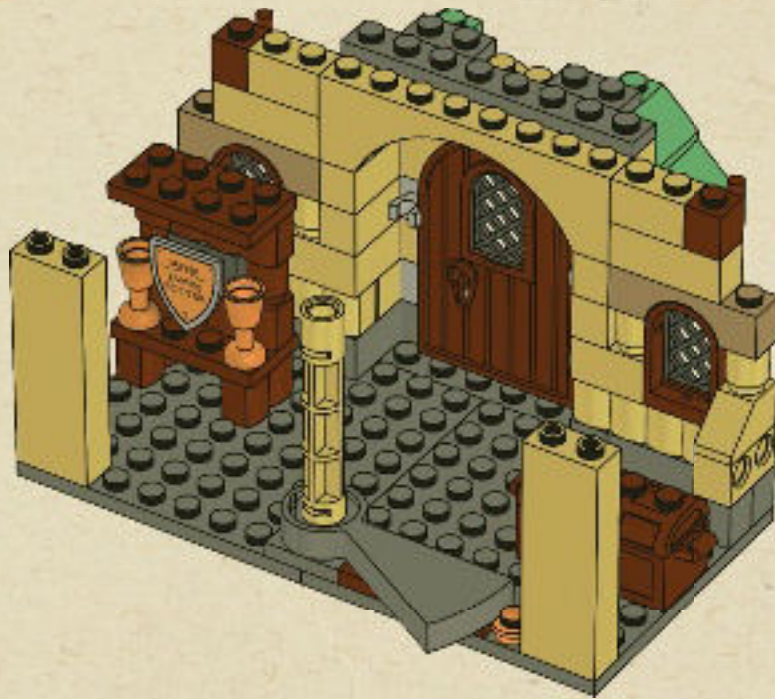

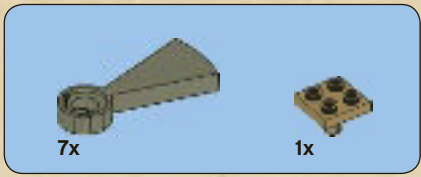

# 21



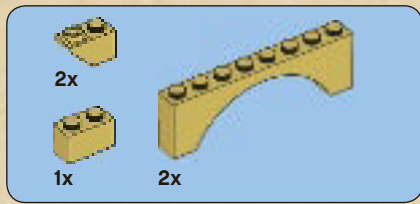

22

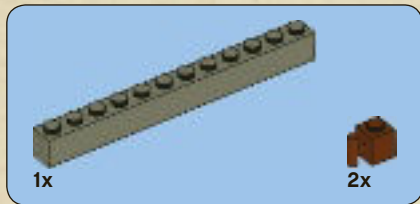
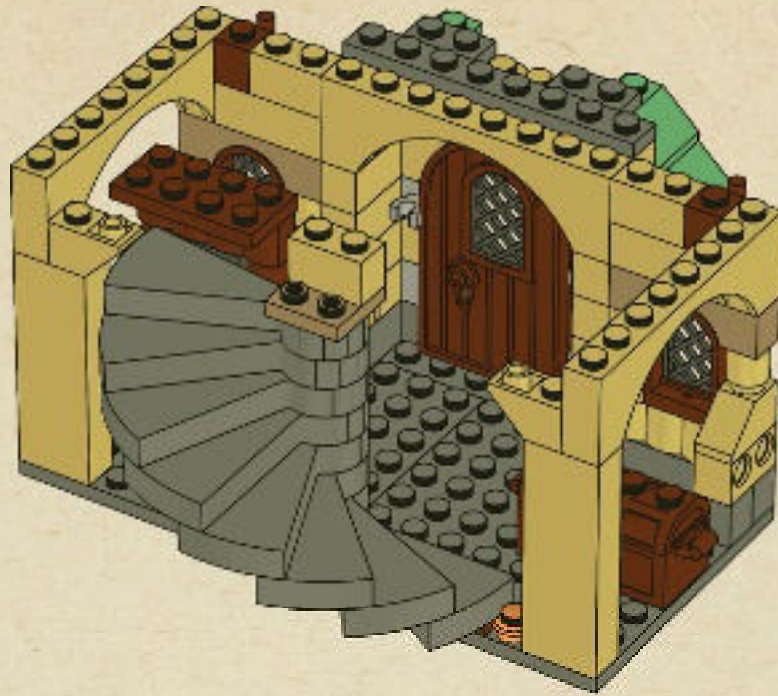

23

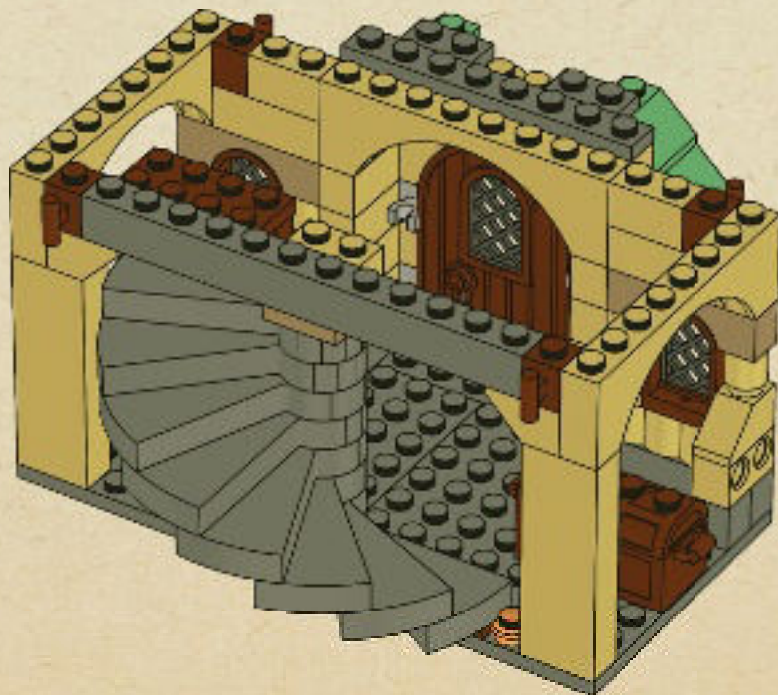



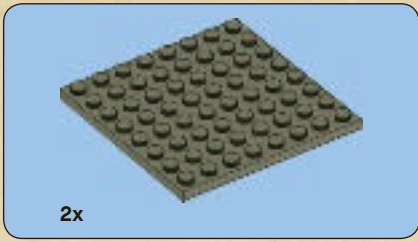

24

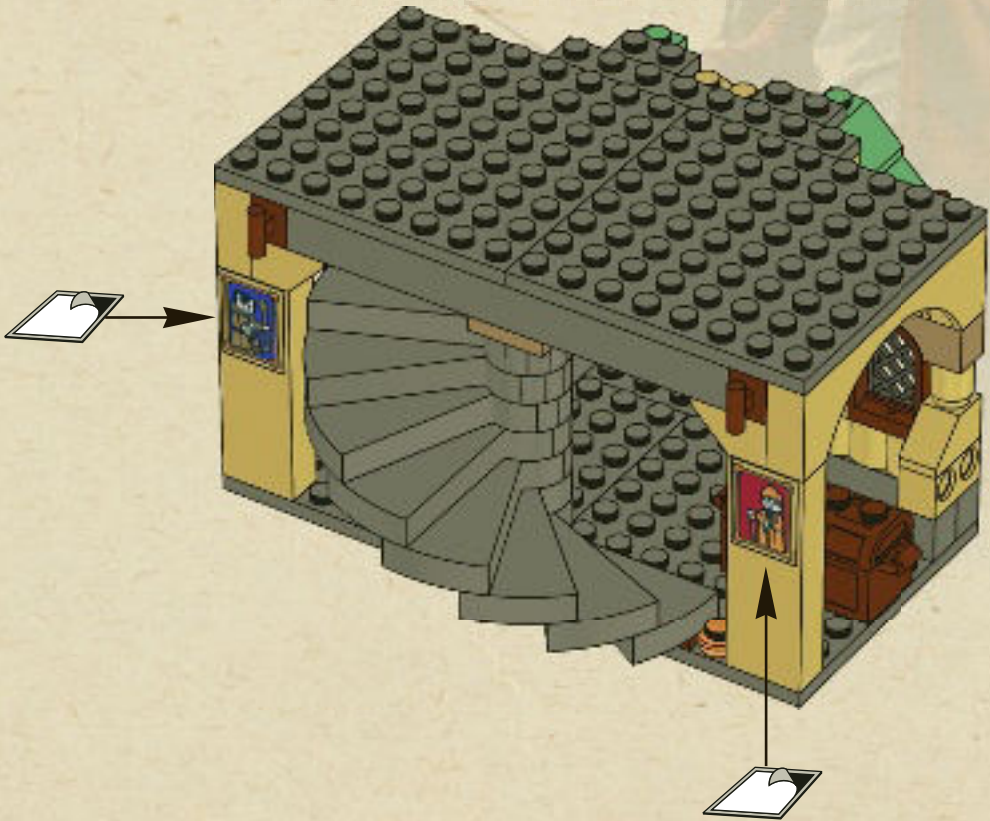



# 25

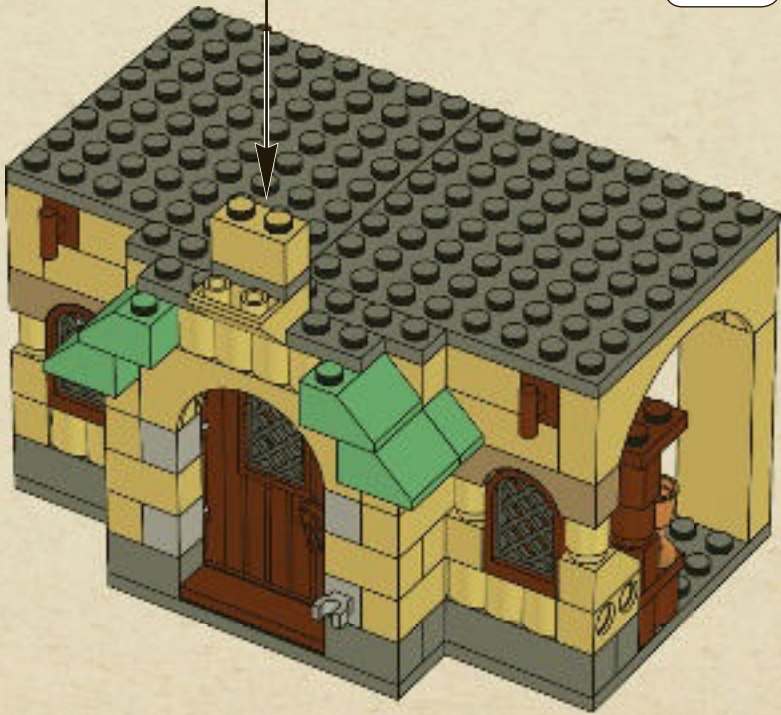
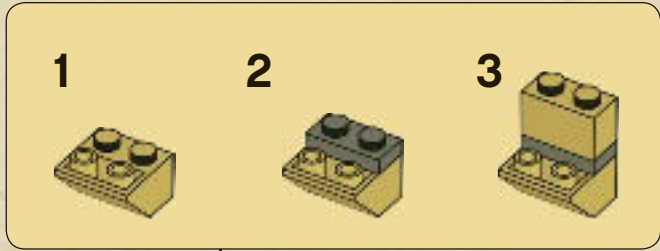



2x

# 26

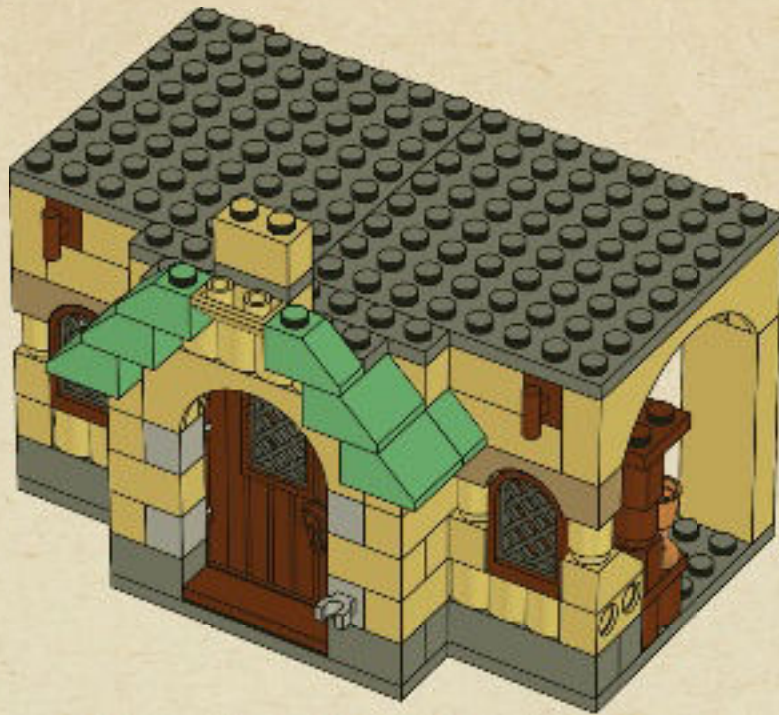

2x

# 27

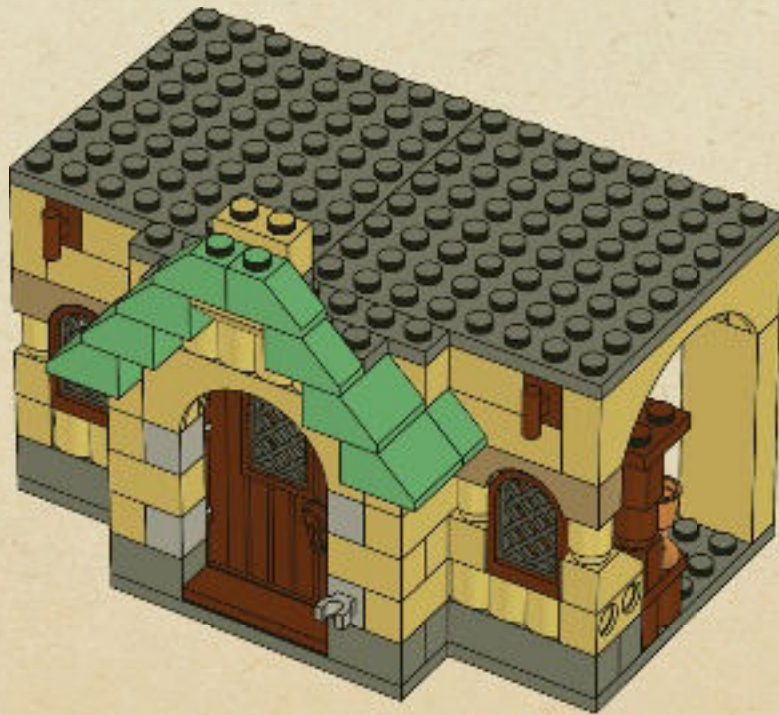



1x

# 28

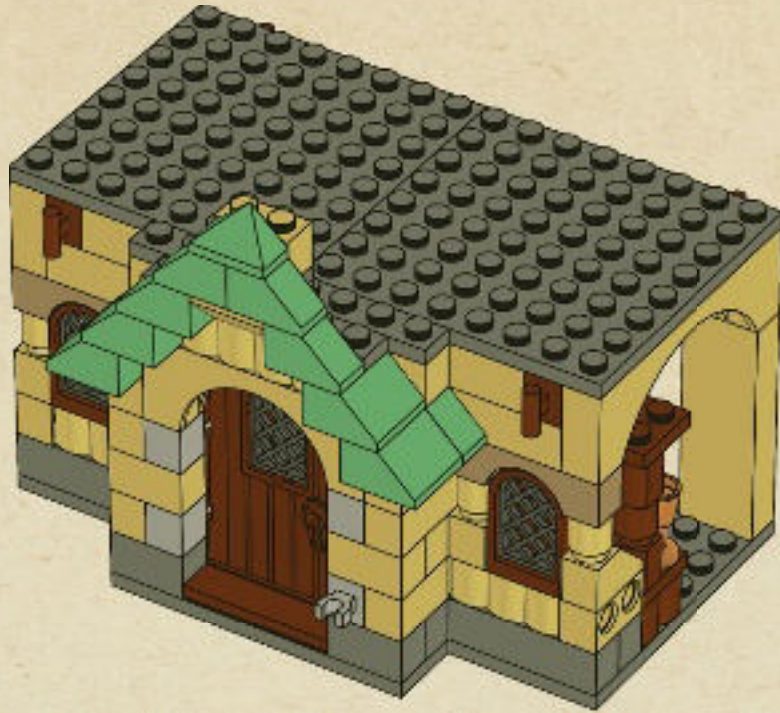

1x



1x

# 29



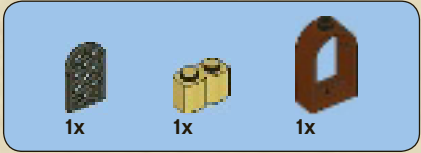
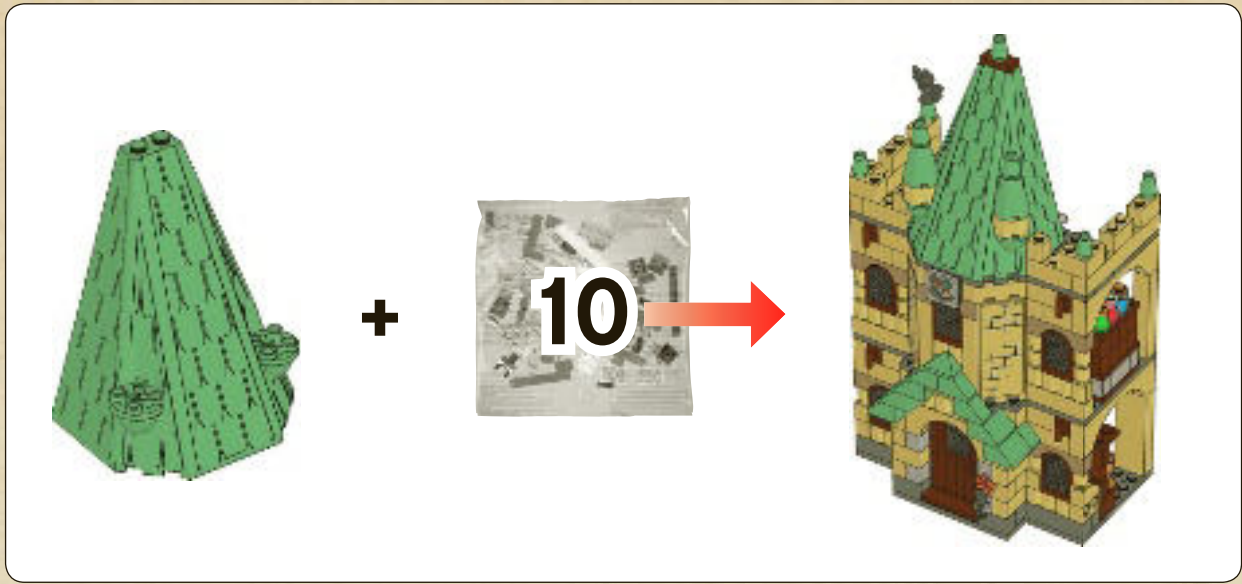

30



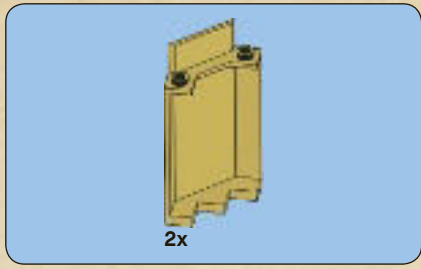

# 31

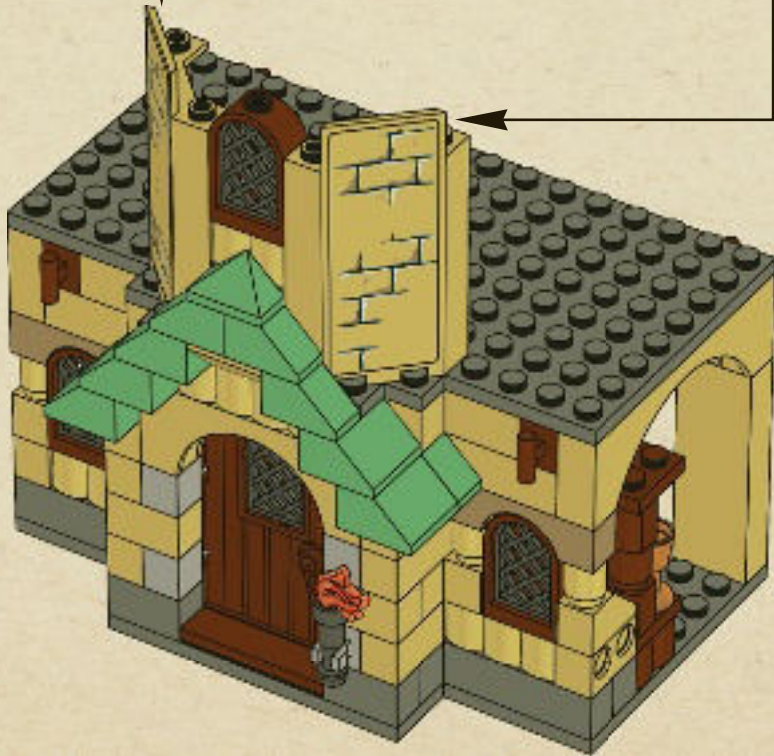
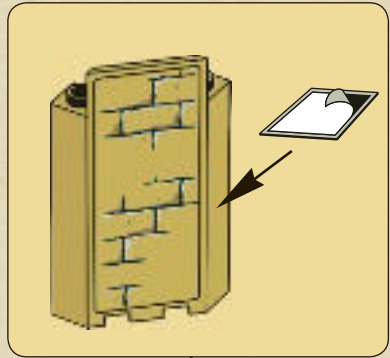
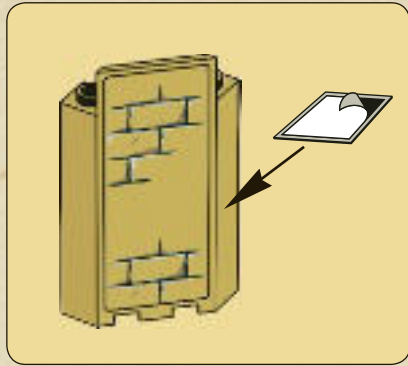



1

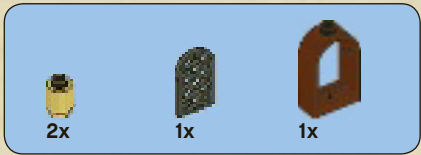
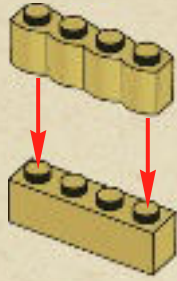

2



3

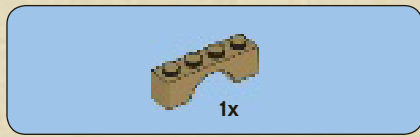

4



2x

32

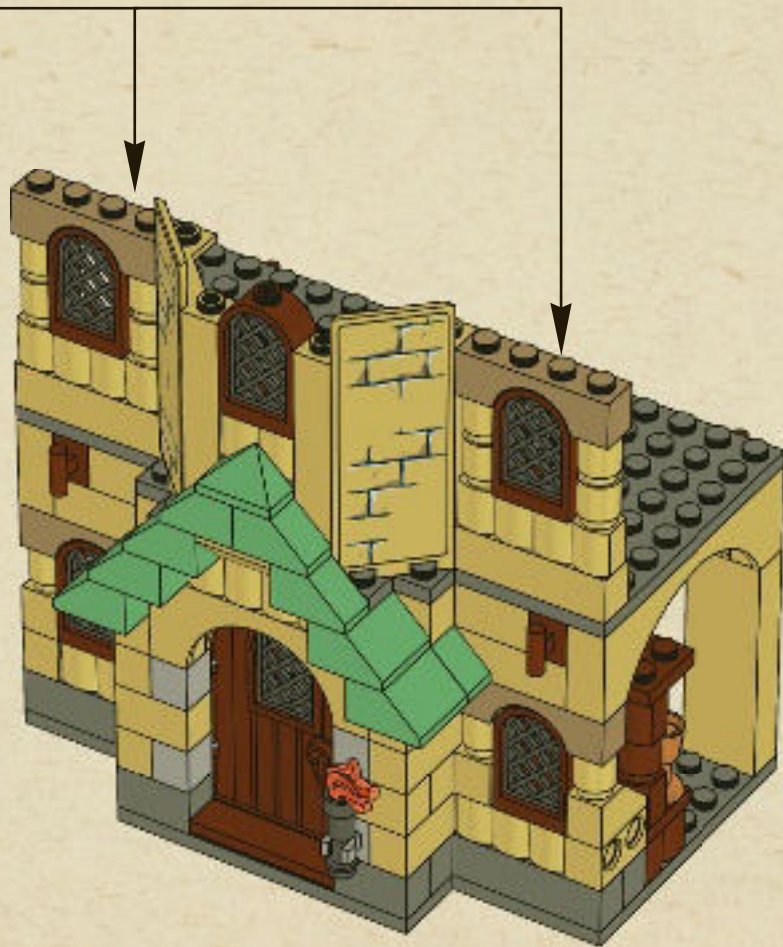



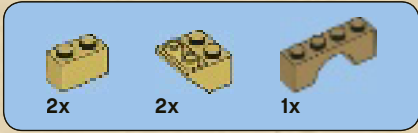

# 33

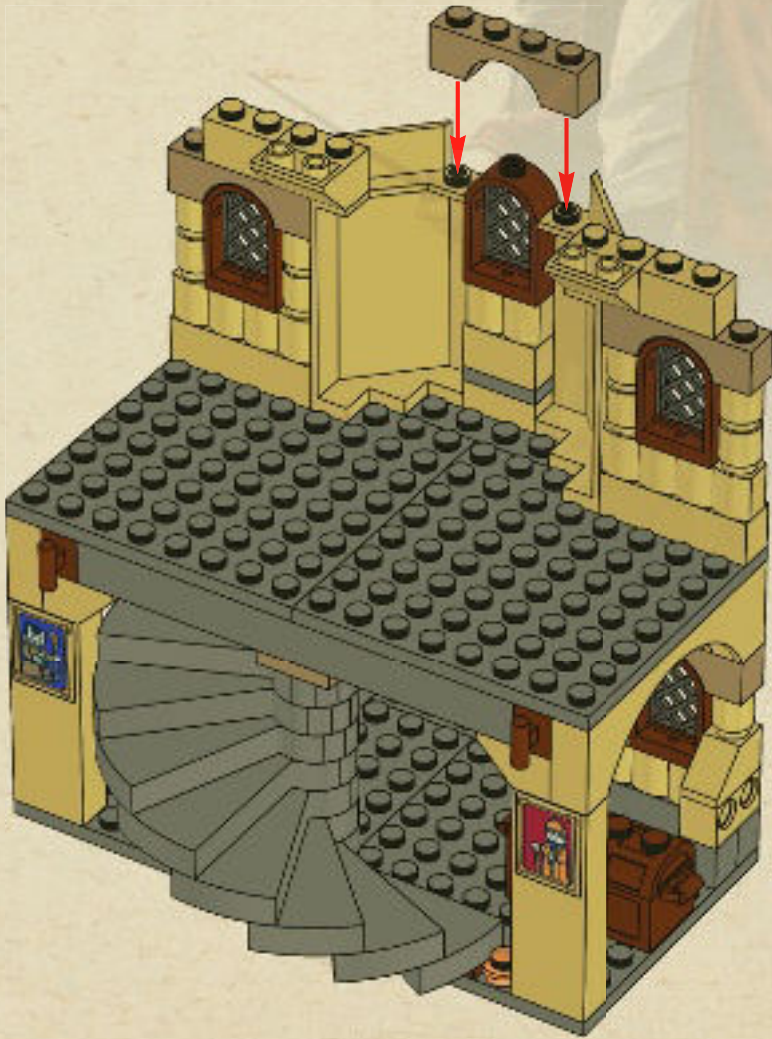



# 34

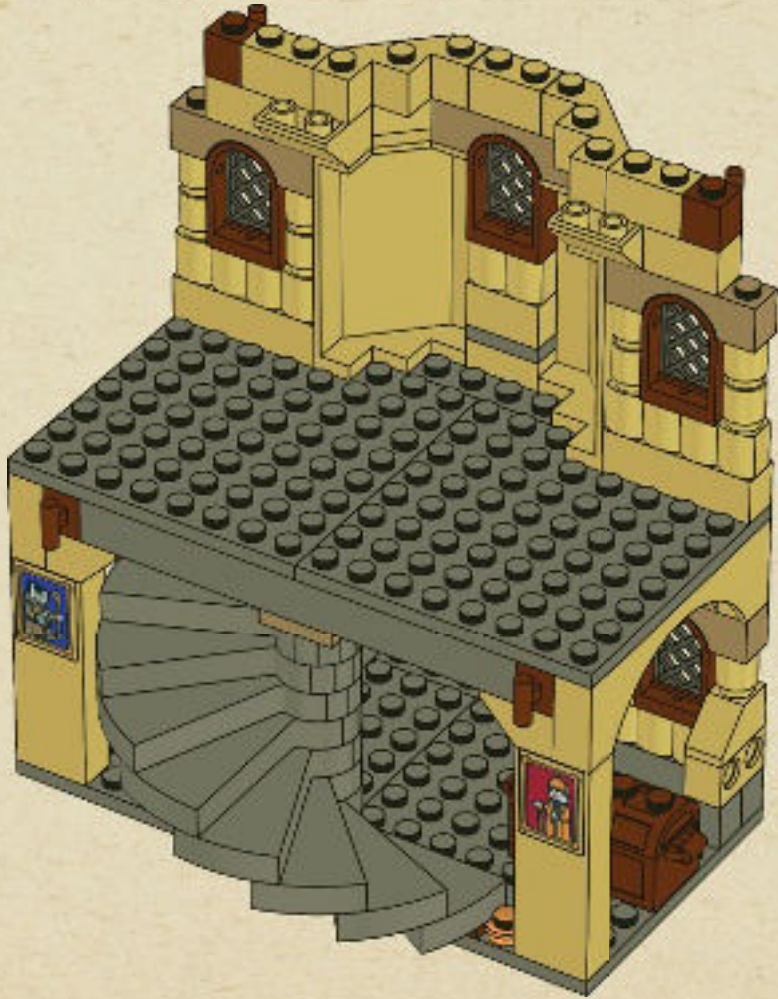



1x



1x

# 35

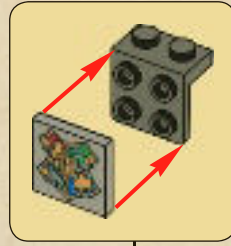

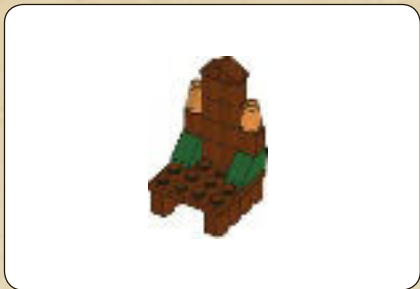

1

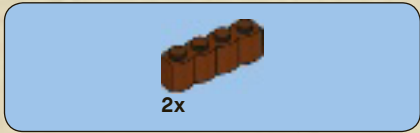

2



3



4





5



6



36



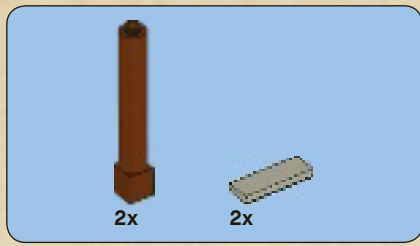

37

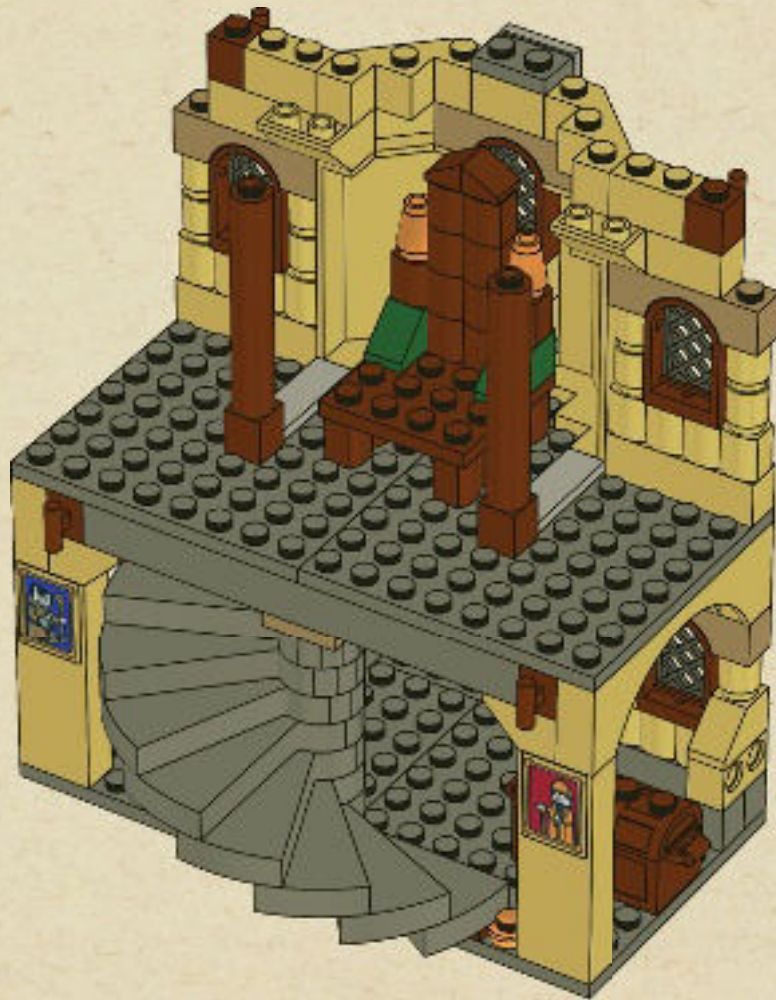



2x

# 38





1

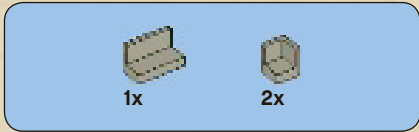

2

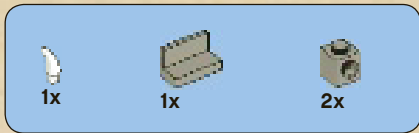
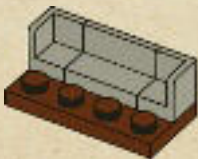

3



4

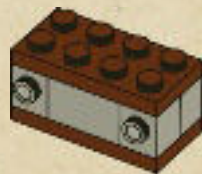



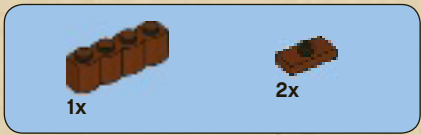

5



7



6



8





1x

1x

9



39

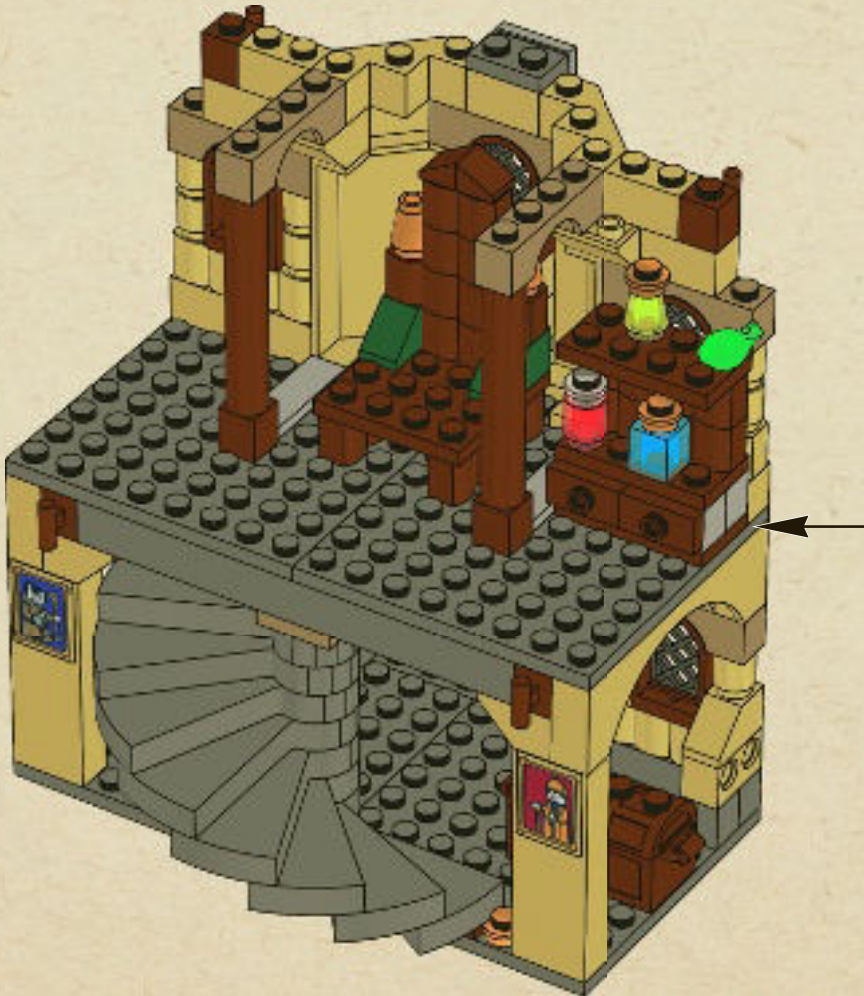



1

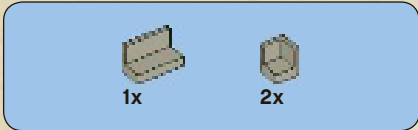

2

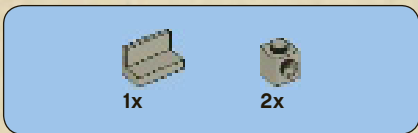
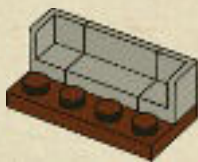

3

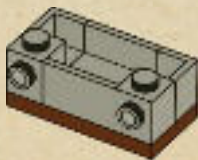

4

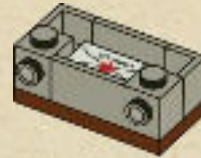

5

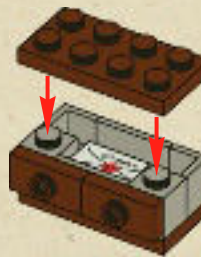

6





7



8



9



10



40





1



2

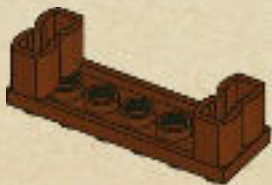

3



4





1x



1x

5



41



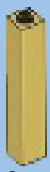

2x

# 42





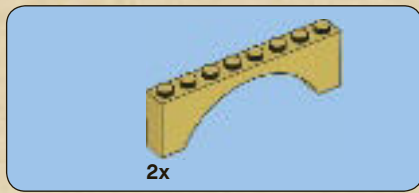

43





# 44



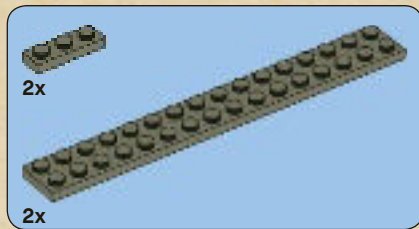

45



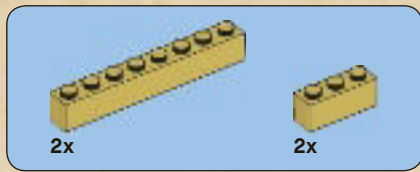

# 46





47





# 48





1x



4x

# 49





# 50

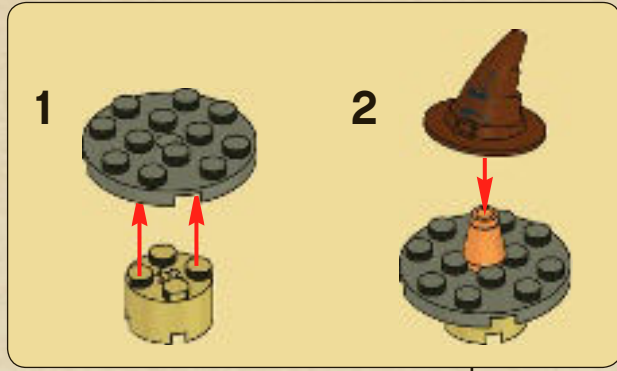



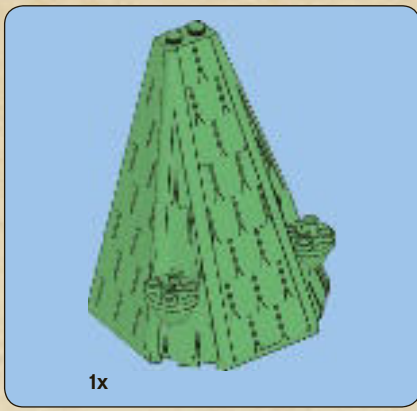

51





# 52





1x



1x

# 53



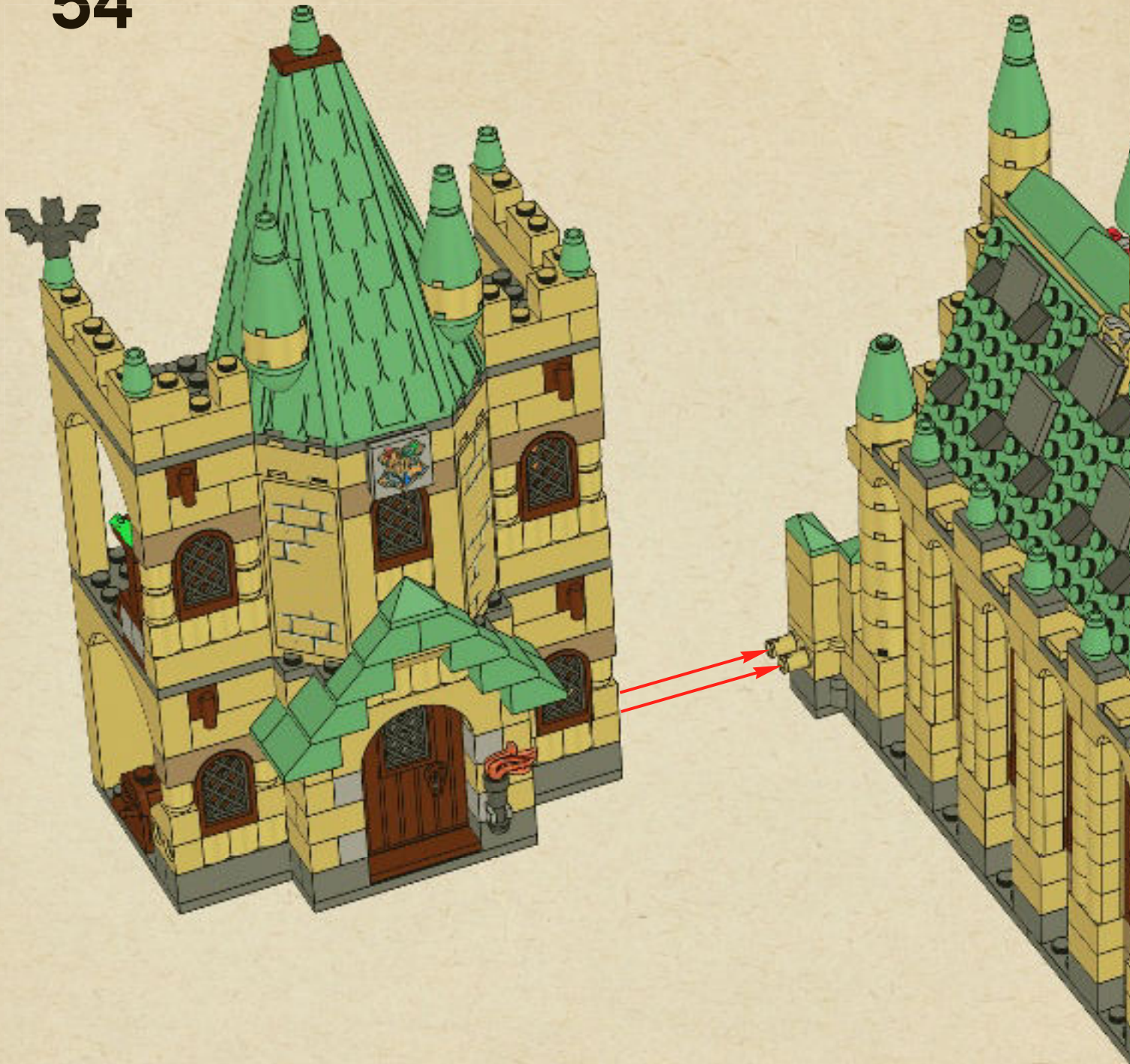

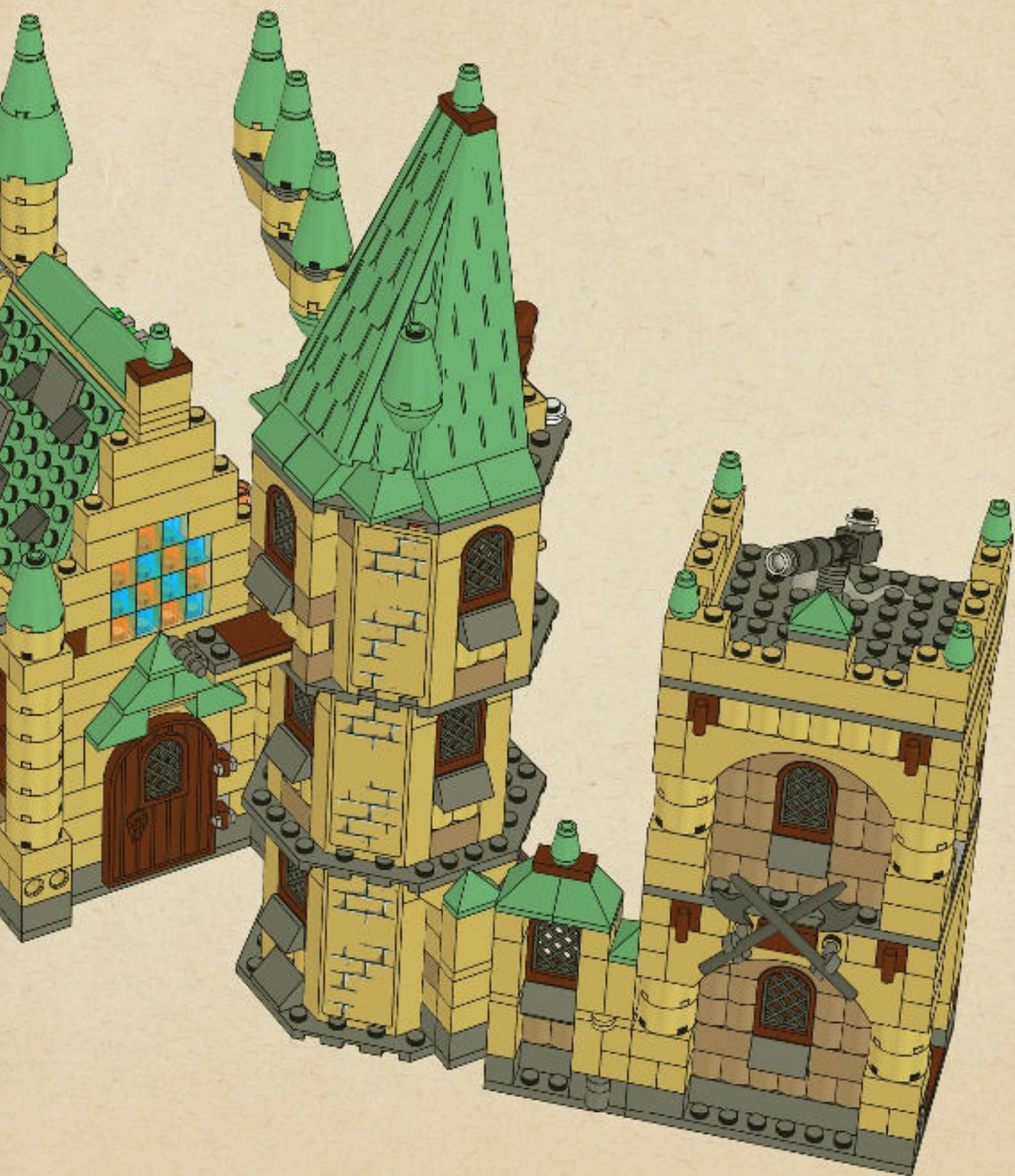







6x 4518400  
1x 4119410  
2x 614101  
2x 4515347  
1x 4129836  
1x 4597233  
1x 4568387  
1x 4596754  
8x 4112980  
21x 4113915  
72x 4109995  
14x 4159279  
8x 4114064  
16x 4114306  
10x 4124455  
15x 4162465  
2x 4159739  
10x 4113916

12x 4579260  
42x 4218749  
6x 4599519  
6x 4523148  
14x 4117070  
2x 4598467  
10x 4523145  
12x 4159196  
1x 4288363  
4x 4112982  
12x 4159774  
1x 4201062  
2x 4114309  
1x 4113993  
4x 4249019  
7x 4596319  
15x 4550323  
2x 4114073

7x 4125253  
10x 4113917  
1x 4594309  
1x 4596918  
1x 4114084  
47x 4125220  
7x 4118866  
7x 4114322  
4x 4121972  
2x 4129996  
1x 4217562  
4x 4227507  
2x 4161734  
2x 4140562  
8x 4594782  
1x 4124460  
1x 4508646  
1x 306221  
1x 306821  
1x 403221

1x 4523404  
2x 407921  
4x 614121  
1x 4114585  
1x 4515349  
6x 362226  
7x 300226  
4x 301026  
1x 4558954  
1x 4233487  
2x 4118624  
1x 4253815  
2x 306226  
12x 4504382  
2x 302226  
1x 362326  
1x 371026  
2x 255526  
1x 4517925  
1x 379426  
1x 614126  
18x 3004626  
1x 459926

1x 73587  
4x 4538456  
1x 4140303  
1x 4597471  
4x 9339  
1x 4611992  
1x 4596914  
1x 4597469  
1x 4597232  
1x 362626  
1x 4157659  
2x 4277668  
1x 4568933  
1x 4179876  
1x 434926  
4x 4118867  
2x 4124171  
1x 4106513  
1x 4113209

2x 4532220  
4x 368026  
1x 4517986  
1x 4597644  
1x 4121715  
2x 4526982  
2x 407926  
4x 4529239  
1x 4107762  
1x 403228  
1x 4598486  
1x 4157270  
2x 4249063  
1x 4106556  
4x 3005740  
2x 4186513  
2x 4100381  
1x 4567334

2x 4597417  
1x 4597340  
1x 4596174  
1x 3006844  
15x 4119350  
1x 3006843  
2x 3000240  
1x 4114128  
1x 3006848  
1x 4567333  
4x 4183133  
1x 4294982  
1x 4267425  
1x 4596937  
2x 4541618  
30x 4521914  
5x 4247151  
15x 4520257  
10x 4596218

2x 4255624  
1x 4597074  
1x 4596942  
1x 4587616  
1x 4597294  
9x 4597660  
23x 4520959  
12x 4593755  
1x 4595809  
12x 4598055  
4x 4597012  
10x 4597014  
4x 4597643  
3x 4595790  
2x 4598536

1x 3006841  
1x 4544720  
1x 4286789  
8x 4249039  
1x 4587105  
1x 4529351  
1x 4611879  
1x 71014  
1x 4611881  
1x 4113954  
1x 4603517  
2x 4211183  
4x 4529242  
10x 4504376  
16x 4225469  
2x 4211242

1x 4597074  
1x 4597340  
1x 4596174  
1x 3006844  
15x 4119350  
1x 3006843  
2x 3000240  
1x 4114128  
1x 3006848  
1x 4567333  
4x 4183133  
1x 4294982  
1x 4267425  
1x 4596937  
2x 4541618  
30x 4521914  
5x 4247151  
15x 4520257  
10x 4596218

1x 4597074  
1x 4597340  
1x 4596174  
1x 3006844  
15x 4119350  
1x 3006843  
2x 3000240  
1x 4114128  
1x 3006848  
1x 4567333  
4x 4183133  
1x 4294982  
1x 4267425  
1x 4596937  
2x 4541618  
30x 4521914  
5x 4247151  
15x 4520257  
10x 4596218

1x 4597074  
1x 4597340  
1x 4596174  
1x 3006844  
15x 4119350  
1x 3006843  
2x 3000240  
1x 4114128  
1x 3006848  
1x 4567333  
4x 4183133  
1x 4294982  
1x 4267425  
1x 4596937  
2x 4541618  
30x 4521914  
5x 4247151  
15x 4520257  
10x 4596218

1x 4597074  
1x 4597340  
1x 4596174  
1x 3006844  
15x 4119350  
1x 3006843  
2x 3000240  
1x 4114128  
1x 3006848  
1x 4567333  
4x 4183133  
1x 4294982  
1x 4267425  
1x 4596937  
2x 4541618  
30x 4521914  
5x 4247151  
15x 4520257  
10x 4596218

1x 4597074  
1x 4597340  
1x 4596174  
1x 3006844  
15x 4119350  
1x 3006843  
2x 3000240  
1x 4114128  
1x 3006848  
1x 4567333  
4x 4183133  
1x 4294982  
1x 4267425  
1x 4596937  
2x 4541618  
30x 4521914  
5x 4247151  
15x 4520257  
10x 4596218

1x 4597074  
1x 4597340  
1x 4596174  
1x 3006844  
15x 4119350  
1x 3006843  
2x 3000240  
1x 4114128  
1x 3006848  
1x 4567333  
4x 4183133  
1x 4294982  
1x 4267425  
1x 4596937  
2x 4541618  
30x 4521914  
5x 4247151  
15x 4520257  
10x 4596218



- 22x 421180
- 4x 421149
- 4x 4211200
- 4x 4211220
- 3x 4211225
- 3x 4211189
- 5x 4211194
- 3x 4579690
- 8x 4211186
- 1x 4221590
- 2x 4561915
- 1x 4211163
- 1x 4533101
- 9x 4211181
- 1x 4243838
- 3x 4211247
- 9x 4211211
- 1x 4225700
- 2x 4617863
- 2x 4508616
- 1x 4211151
- 4x 4211150
- 1x 4586043
- 2x 4211152
- 2x 4520612
- 1x 4211221
- 2x 4211197
- 13x 4219726
- 1x 4211159
- 16x 4542131
- 15x 4595814
- 16x 4225823
- 4x 4215496
- 3x 4262974
- 1x 4506003
- 1x 4611993
- 1x 4596335
- 3x 4598334

- 2x 4211388
- 2x 4211349
- 4x 4558953
- 6x 4533772
- 4x 4211460
- 4x 4211461
- 3x 4211684
- 2x 4211398
- 1x 4594330
- 1x 4596917
- 4x 4558169
- 1x 4211438
- 3x 4556157
- 2x 4222019
- 4x 4215513
- 4x 4211515
- 1x 4227657
- 1x 4292298
- 2x 4227658
- 1x 4211465
- 2x 4518282
- 1x 4512743
- 4x 4540203
- 4x 4211805
- 2x 4211098
- 16x 4211088
- 8x 4211060
- 2x 4211105
- 2x 4211103
- 2x 4210848
- 14x 4211063
- 5x 4211055
- 2x 4596315
- 1x 4611989
- 2x 4211133
- 2x 4211001
- 1x 4211053
- 1x 4211065
- 3x 4528323
- 2x 4210897
- 1x 4211465
- 2x 4518282

- 1x 4225778
- 5x 4210706
- 2x 4210796
- 1x 4226358
- 4x 4583688
- 6x 4211122
- 4x 4210802
- 1x 4210798
- 1x 4211107
- 5x 4211002
- 1x 4210998
- 4x 4211008
- 1x 4210997
- 1x 4211099
- 4x 4210795
- 10x 4567887
- 1x 4211054
- 1x 4512743
- 4x 4540203
- 4x 4211805
- 2x 4211098
- 16x 4211088
- 8x 4211060
- 2x 4211105
- 2x 4211103
- 2x 4210848
- 14x 4211063
- 5x 4211055
- 2x 4596315
- 1x 4611989
- 2x 4211133
- 2x 4211001
- 1x 4211053
- 1x 4211065
- 3x 4528323
- 2x 4210897
- 1x 4211465
- 2x 4518282

- 4x 4210900
- 2x 4596208
- 2x 4597114
- 1x 4287814
- 1x 4596738
- 2x 4289542
- 2x 4603212
- 1x 4210695
- 1x 421069
- 1x 4210892
- 9x 4211119
- 1x 4277928
- 2x 4210660
- 2x 4211129
- 2x 4225733
- 2x 4210633
- 4x 4221591
- 15x 4262655
- 1x 4567338
- 4x 4210900
- 2x 4596208
- 2x 4597114
- 1x 4287814
- 1x 4596738
- 2x 4289542
- 2x 4603212
- 1x 4210695
- 1x 421069
- 1x 4210892
- 9x 4211119
- 1x 4277928
- 2x 4210660
- 2x 4211129
- 2x 4225733
- 2x 4210633
- 4x 4221591
- 15x 4262655
- 1x 4567338

- 2x 4278013
- 1x 4273743
- 1x 4540849
- 1x 4597573
- 1x 4597036
- 1x 4597037
- 1x 4596302
- 1x 4596915
- 1x 4596916
- 1x 4597398
- 4x 4529247
- 2x 4587002
- 8x 4523159
- 8x 4505990
- 1x 4287800
- 6x 3005747
- 8x 4540865

  
**Customer Service**  
 Kundenservice  
 Service Consommateurs  
 Servicio Al Consumidor  
[www.lego.com/service](http://www.lego.com/service) or dial  
  
 : 00800 5346 5555  
 : 1-800-422-5346



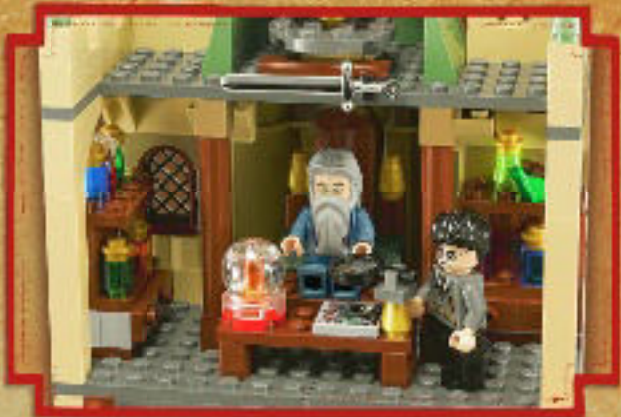



Go to [www.nielsen.com/LEGO](http://www.nielsen.com/LEGO) to fill out a survey for a chance to win a cool LEGO® Product. No purchase necessary. Open to all residents where not prohibited.

 [www.LEGO.com](http://www.LEGO.com)

# [www.nielsen.com/LEGO](http://www.nielsen.com/LEGO)

**GEWINNE!**

Nimm an der Umfrage auf [www.nielsen.com/LEGO](http://www.nielsen.com/LEGO) teil und hab die Chance ein cooles LEGO® Produkt zu gewinnen!

Die Teilnahme am Gewinnspiel führt zu keinerlei Kaufverpflichtungen. Teilnahme in allen nicht ausgeschlossenen Ländern möglich.

**WIN!**

Ga naar [www.nielsen.com/LEGO](http://www.nielsen.com/LEGO), vul een enquêteformulier in en maak kans op een cool LEGO® product.

Geen aankoopverplichting. Iedereen mag deelnemen, uitgezonderd ingezetenden van landen waar een enquêteverbod geldt.

**GAGNE!**

Visite [www.nielsen.com/LEGO](http://www.nielsen.com/LEGO) pour répondre à un questionnaire et avoir une chance de gagner un produit LEGO® très cool!

Aucune obligation d'achat. Ouvert à tous les résidents des pays autorisés.

**当てよう!**

[www.nielsen.com/LEGO](http://www.nielsen.com/LEGO)にアクセスして、アンケートにご記入ください。当選者にはレゴ製品を差し上げます。

お買い上げの必要はありません。禁止されていない限り、すべての国籍にご利用いただけます。

LEGO and the LEGO logo are trademarks of the LEGO Group. ©2010 The LEGO Group. ©2010 Lucasfilm Ltd. & TM. All rights reserved. Used under authorization. HARRY POTTER, characters, names and related indicia are trademarks of and © Warner Bros. Entertainment Inc. Harry Potter Publishing Rights © JKR. TM & © Warner Bros. Entertainment Inc. (S10)